



المؤسسة العامة للتدريب التقني والمهني
Technical and Vocational Training Corporation



الحقيبة التدريبية

اللغة الإنجليزية 1



055 813 3778 - 053 483 5311



www.alruwad.edu.sa

مؤسسة التدريب العالمية

Technical English 1

Course Book



David Bonamy

Technical English 1

Course Book



David Bonamy

Contents

Unit 1 Check-up	1.1 Basics p.4	Meeting and greeting people Using forms Following instructions	Verb <i>be</i> <i>I'm</i> <i>Can/could</i> . <i>I'm a technician</i> . Imperatives	Basic vocabulary: say, write ... Tools, fittings, electrical parts, occupations
	1.2 Letters and numbers p.6	Exchanging information Using forms Units of measurement	How do you spell ... ?	Personal details Cardinal numbers Alphabet Abbreviations of units: kg, m
	1.3 Dates and times p.8	Using numbers Talking about travel timetables Making appointments	<i>LH three oh six, Monday the twenty-eighth of December</i>	Ordinal numbers Cases and times Decimals
Unit 2 Parts (1)	2.1 Naming p.10	Identifying things	What's that? <i>I think it's a car</i> . What's this called? <i>this, that, these, those</i>	Parts: wheel, axle, plate ... Fittings: nuts, bolts, nails ... Vehicles: car, bike, plane ...
	2.2 Assembling p.12	Using checklists Saying what you need for a job Using an instruction manual	<i>I need some bolts. What size?</i> Imperative + object + location: <i>Put the wheel on the axle</i> .	Verbs: loosen, tighten, push ... Linear: mm, m, millimetre
	2.3 Ordering p.14	Using voicemail Ordering by phone Introducing yourself and others	How many do you need? What's your name? Please spell that.	Numbers: double 5, zero Sizes: small, medium, large Colours: red, blue, black ...
Review Unit A p.16				
Unit 3 Parts (2)	3.1 Tools p.20	Describing components Using a product review	Present simple of <i>have</i> <i>My multi-tool has blades and a spanner</i> .	Tools: spanner, (a pair of) pliers Parts of tools: shaft, blade, head ...
	3.2 Functions p.22	Saying what things do Describing a product Talking about people's jobs	Present simple What does this handle do? Where do you work?	Verbs: measure, grip, cut, open ... Everyday tools: torch, alarm ... Occupations: operator, technician ...
	3.3 Locations p.24	Saying where things are	Adverbials and prepositions of location <i>Where is it? It's at the top</i> .	Location: top, bottom, middle ... Computer and electronic equipment
Unit 4 Movement	4.1 Directions p.26	Describing direction of movement	Adverbials of direction <i>can, can't, cannot</i> <i>Can a helicopter fly backwards? Yes, it can.</i>	Direction: up, down, forwards ... Adverb: straight, vertically ... Angles: degrees
	4.2 Instructions p.28	Using an instruction manual	Imperative + present simple <i>Push the joystick upwards and the plane accelerates</i> .	Movement: ascend, descend ... Controls: joystick, slider ... Speed: km/h, m/s
	4.3 Actions p.30	Using an instruction manual Giving and following instructions Explaining what happens	When clause <i>When you pull the lever backwards, the truck reverses</i> .	Movement: drive, reverse ...
Review Unit B p.32				
Unit 5 Flow	5.1 Heating system p.36	Explaining how fluids move around a system Using a flow chart	Present simple <i>The water flows through the pipe into the tank</i> . Prepositions of movement	Parts of a fluid system: inlet ... Prepositions: into, out of, to ... Verbs: enter, flow, sink ...
	5.2 Electrical circuit p.38	Explaining how an electrical circuit works	Zero conditional <i>If the battery is empty, the current doesn't flow</i> .	Circuit: battery, conductor ... Electrical units: ampere, watt
	5.3 Cooling system p.40	Explaining how cooling systems work Describing everyday routine	Reference words: <i>here, it, this</i> Present simple in routine	Cooling system parts: engine, fan ... Temperature: degree Celsius
Unit 6 Materials	6.1 Materials testing p.42	Giving a demonstration Explaining what you're doing	Present continuous <i>I'm stretching the rope</i> .	Verbs: bend, cut, compress ... Spelling: <i>enkeisenberg</i> ...
	6.2 Properties p.44	Describing the properties of materials	What's it made of? <i>You can't bend it, it's rigid</i> .	Materials: aluminium, graphite ... Properties: hard, rigid, tough ...
	6.3 Buying p.46	Using a customer call form Buying and selling by phone Checking Starting a phone call	What's your email address? <i>Could you spell/repeat that?</i> <i>How many would you like?</i>	Email/Web addresses: at, dot ... Prices: euro, dollar
Review Unit C p.48				

Grammar summary p.100

Reference section p.106

Unit 7 Specifications	7.1 Dimensions p.52	Specifying dimensions Using a specifications chart	How long is it? It's 9 mm long. The length of the road is 120 km.	Bridge parts: deck, pier, pylon Adjectives/nouns: long/length, high/height Linear and weight: mm, m, kg ...
	7.2 Quantities p.54	Specifying materials Buying materials for a job Using a materials checklist	Countable and uncountable nouns <i>I'd like some paint, please.</i>	Substances: glue, cement, oil ... Containers: tube, tin, bag ... Area and volume: m ² , m ³ , litre ...
	7.3 Future projects p.56	Describing plans for the future Using a Gantt chart	will, won't Time expressions: in 2016, at the end of 2015	Verbs: attach, complete, connect ...
Unit 8 Reporting	8.1 Recent incidents p.58	Taking an emergency call Explaining what has happened Checking on progress	Present perfect <i>I've checked the brakes.</i> <i>Have you checked the tyres?</i>	Car repair: brakes, exhaust pipe ... Building site: beam, bucket, digger ...
	8.2 Damage and loss p.60	Reporting damage Dealing with a customer	Past participles as adjectives: <i>It's broken.</i> <i>They're dented.</i> <i>There are some scratches on the screen.</i> <i>There's no user manual.</i>	Electrical: antenna, plug ... Damage: bent, broken, dented ... Loss: missing ...
	8.3 Past events p.62	Discussing past events Phoning a repair shop	Past simple <i>They launched it in 2006.</i> Time expressions: in 2006, on 5 th October, fifty years ago ...	Time: today, yesterday, a week ago ... Revision of dates and years more than, less than
Review Unit D p.64				
Unit 9 Troubleshooting	9.1 Operation p.66	Explaining how things work Explaining what things do	Revision of present simple <i>The handlebar steers the airboard.</i>	Verbs: control, drive, press ... Parts: body, lever ... Connections: attached to, mounted on ...
	9.2 Hotline p.70	Listening to an automated phone message Using a service hotline Taking a customer through a problem and solution	Is the computer connected to the adapter? Short answers: Yes, I have. No, it doesn't. Yes, it is.	Electronics and computing: RF/SCART socket, router, modem ... Connections: connected to
	9.3 User guide p.72	Using a flow chart Using a troubleshooting guide	Zero conditional + imperative <i>If it doesn't start, check the cable.</i>	Electronics: LED, loose (cable) ... Computing: disk drive, printer ... Car repair: fan (battery) ...
Unit 10 Safety	10.1 Rules and warnings p.74	Following safety rules Giving and following warnings Using safety signs	could, might, must <i>Always ... Don't ... You mustn't ...</i> <i>You might trap your hand.</i>	Safety gear: hard hat, gloves ... Hazards: poison, danger ... Accidents: hurt, injure, slip ... Shapes: circular, round ...
	10.2 Safety hazards p.76	Giving and following warnings Noticing safety hazards Reporting safety hazards	Past tense of be <i>The fire exit was locked.</i> <i>There were no fire extinguishers.</i>	Hazard nouns: gap, bare wire ... Hazard adjectives: coiled, damaged, locked ... Safety: fire exit, safety cone ...
	10.3 Investigations p.78	Investigating an accident Reporting an accident Giving, accepting and turning down an invitation	Questions in the past simple <i>Where? When? How high? What? How far? How many?</i>	Nouns on a form: position, altitude, distance ...
Review Unit E p.80				
Unit 11 Cause and effect	11.1 Pistons and valves p.84	Expressing causation, permission and prevention Explaining how a four-stage cycle works	Verb constructions <i>cause, allow + to infinitive</i> <i>make, let + bare infinitive</i> <i>stop, prevent + from + gerund</i>	Hydraulics: chamber, inlet, outlet ...
	11.2 Switches and relays p.86	Explaining how a relay circuit works Giving an oral presentation	Further practice of verb patterns in 11.1	Electrical: battery, buzzer, earth ...
	11.3 Rotors and turbines p.88	Explaining how a wind turbine works Giving an oral presentation Making suggestions	Further practice of verb patterns in 11.1 Reference words: it, one	Turbines: blade, brake, gear ... Verbs: drive, rotate, send ...
Unit 12 Checking and confirming	12.1 Data p.90	Describing specifications Expressing approximation Checking that data is correct	Revision of question forms <i>is that correct? No, that's wrong.</i>	Approximation: about, over, at least ... Nouns: mass, rotation
	12.2 Instructions p.92	Following spoken instructions Confirming actions Describing results of actions	Revision of imperative with present continuous	Revision of controls, vehicles, direction adverbs, verbs of movement
	12.3 Progress p.94	Describing maintenance work Checking progress with a Gantt chart	Revision of present perfect, past simple, present continuous, and will	Maintenance and repair: check, inspect, assemble ...
Review Unit F p.96				

1 Basics



Start here 1 02 Listen and complete the dialogues with the words in the box.

am are I'm is name's

- 1 ● Hello. I (1) am Hans Beck.
 Hi. My name (2) _____ Pedro Lopez.
 ● Pleased to meet you.
- 2 ● Excuse me. (3) _____ you Mr Rossi?
 Yes, I am.
 ● Pleased to meet you, Mr Rossi. (4) _____ Danielle Martin.
 Nice to meet you, Danielle.
- 3 ● Hi. My (5) _____ Jamal.
 Hello, Jamal. (6) _____ Borys.
 ● Good to meet you, Borys. (7) _____ you from Russia?
 No, (8) _____ from Poland.

2 Work in pairs. Practise the dialogue in 1 with your partner. Talk about yourself.

Writing 3 Complete the form about yourself. Use block capitals.

Name	Country	Occupation
_____	_____	_____

Speaking 4 Work in pairs. Ask and answer questions.

- A: Hello. What's your name? B: I'm Kato.
 A: Where are you from? B: I'm from Japan.
 A: What do you do? B: I'm a builder/an electrician/a student.

I am → I'm
 My name is → My name's
 What is → What's

What do you do? = What's your job/occupation?

Listening 5  03 Play this game. Listen. Only follow the instructions if the speaker says *Please*.

Vocabulary 6 Match the opposites.

pick up raise read say stand start

listen lower put down sit stop write

Example: stand ≠ sit

7 Try this quiz. Choose the correct answer.



- | | | | |
|-----------------|----------------|----------------|-------------------|
| 1 The TV is | a) on. | b) off. | |
| 2 The doors are | a) closed. | b) open. | |
| 3 Turn | a) left. | b) right. | |
| 4 Go | a) in. | b) out. | |
| 5 Drive | a) up. | b) down. | |
| 6 The hammer is | a) in the box. | b) on the box. | c) under the box. |

8 Match the pictures with the words in the box.

adapter antenna bolts cable chisel nuts plug
saw screws screwdriver spanner washers

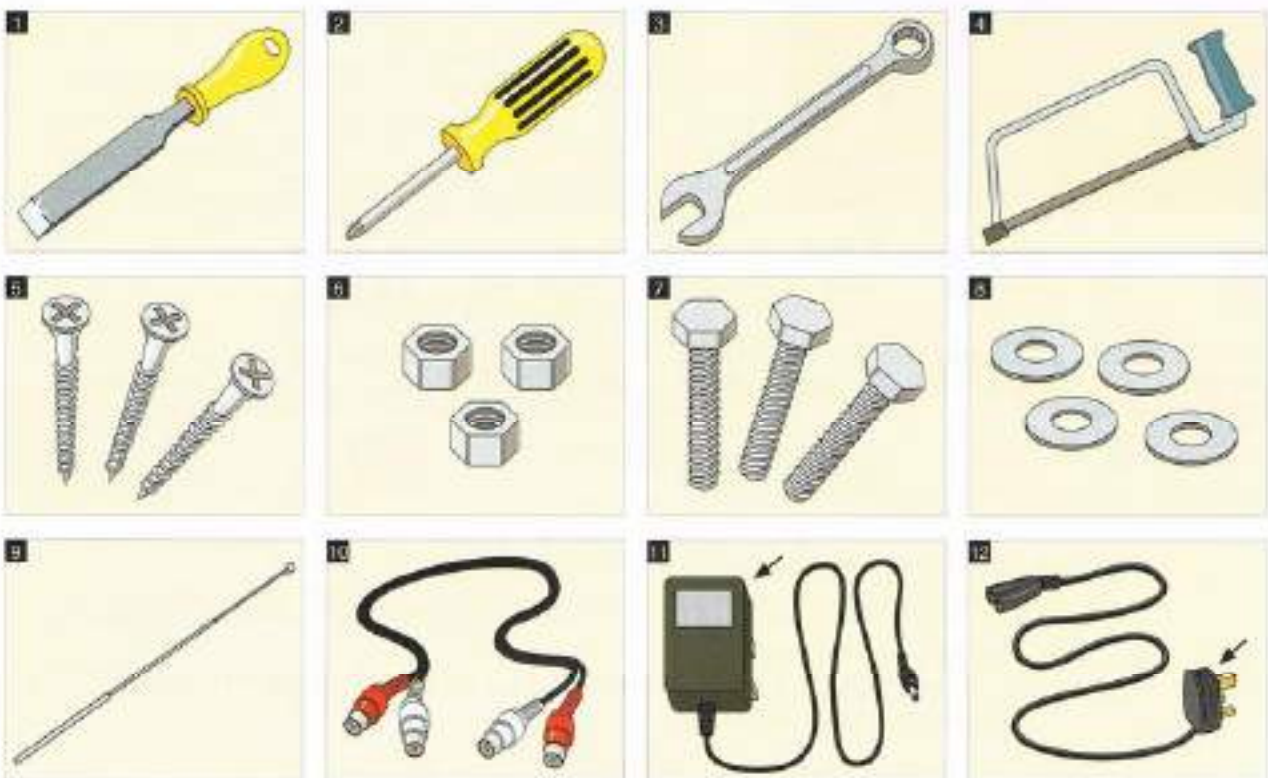

2 Letters and numbers

- Start here** 1 04 Listen and correct the four mistakes in the business card.
- Listening** 2 05 Listen and complete the forms.



1

Surname	___ A ___ L ___
Company	_____
Email address	___ q ___ @ ___ .com

2

Emergency service	FIRE
Address	___ E ___ S ___ Street
Postcode	___ 4 ___ N ___
Surname	___ A T ___ E ___ S



3

Problems with your product?
Phone CUSTOMER SERVICE HELPLINE

Full name	PIETER ___ R ___ U ___
Postcode	2 _____
House number	_____
Model number	___ 8 ___

- Speaking** 3 Dictate and spell out details from your business card to your partner.
- 4 Put all the letters of the alphabet into the correct column.

three	eight	five	ten	two	EXCEPTIONS
B _ _ _	A _ _ _	I _ _	E _ _ _	Q _ _	_ _ _
_ _ _ _			_ _ _		

- 5 Work in groups. Have a spelling competition.

Team A: Make a list of ten countries. Check the spelling. Then ask Team B to spell them correctly.

Team B: Make a list of ten capital cities. Check the spelling. Then ask Team A to spell them correctly.

Example: How do you spell EGYPT? How do you spell TOKYO?

Listening 6  06 Listen and match the pictures with the announcements.



7 Listen again and complete the sentences with numbers and letters.

- 1 Counter number _____, please.
- 2 This is Radio _____ on _____ FM.
- 3 Please pay _____ pounds and _____ pence.
- 4 The _____ train to Oxford will depart from platform number _____.
- 5 Flight number _____ is boarding now. Please go to gate number _____.
- 6 To donate money to Live Aid, ring this number now: _____.
- 7 Begin countdown now: _____ ...

Speaking 8 Play *FIZZ BUZZ*.

- Count from 1 to 100 round the class.
- Use *Fizz* for a number you can divide by 3. Example: 3, 6, 9, 12, ...
- Use *Buzz* for a number you can divide by 5. Example: 5, 10, 15, 20, ...
- Use *Fizz Buzz* for a number you can divide by both 5 and 3. Example: 15, 30, ...
- If you make a mistake, you are OUT of the game.

Start like this: 1, 2, Fizz, 4, Buzz, Fizz, 7, 8, Fizz, Buzz, 11, Fizz, 13, 14 ...

Vocabulary 9 What do the following mean?

km + g in kW kg L V
 A ° rpm C km/h W gal
 m £ - ft €

Example: km = kilometre

Listening 10  07 Listen and write the numbers in the correct space.

- | | | |
|------------|--------------|------------|
| 1 _____ °C | 5 _____ ° | 9 _____ W |
| 2 _____ A | 6 _____ km/h | 10 _____ V |
| 3 _____ km | 7 _____ rpm | 11 _____ € |
| 4 _____ m | 8 _____ kg | 12 _____ L |

amps = watts
volts

3 Dates and times

Start here



- 1 08 Listen to the sports results. Add the positions (2nd, 3rd and 5th) and complete the times in the blanks in the chart.

Athens Olympics 2004 Official Results Men's Finals: 1500 metres			
Position	Name	Country	Time
(1)	Silva	Portugal	3:34.68
4 th	Kiptanui	Kenya	(2) 3:_____ . _____
1 st	El Guerrouj	Morocco	(3) 3:_____ . _____
(4)	Lagat	Kenya	3:34.30
6 th	East	Britain	(5) 3:_____ . _____
(6)	Heshko	Ukraine	3:35.82

Speaking

- 2 Put the ordinal numbers **1st** to **31st** into the chart. Read them out to your teacher.

-st	-nd	-rd	-th
1 st ,	2 nd ,	3 rd ,	4 th ,

- 3 Say the names of the months of the year.
 4 Say the days of the week. Start with **Monday**.
 5 Read out these airport codes.

FRA = Frankfurt	WAW = Warsaw	DXB = Dubai	CAI = Cairo
CDG = Paris	MAD = Madrid	FCO = Rome	NRT = Tokyo
LHR = London	BAH = Bahrain	JNB = Johannesburg	LOS = Lagos

- 6 Give the days of the flights.

on Mondays = on Monday every week

Flight number	From	To	Depart	Arrive	Days
1 LH 306	FRA	WAW			1 4
2 AF 835	CDG	MAD			2 4 6
3 EK 971	LHR	BAH			1 2 4 5
4 MS 740	DXB	CAI			1 3 5 7
5 AZ 7788	FCO	NRT			2 3 5 6
6 SA 104	JNB	LOS			1 4 7

1 = Monday 2 = Tuesday 3 = Wednesday 4 = Thursday 5 = Friday 6 = Saturday 7 = Sunday

Example: 1 LH 306 departs from Frankfurt on Mondays and Thursdays.

Listening 7  Listen and write down the dates. Use *dd/mm/yy*.

Speaking 8 Write down some dates important to you. Then dictate them to your partner.

You dictate: *The twenty-eighth of December two thousand and ten.*

Your partner writes: *2010-12-28.*

9 Complete the table. Read out your answers.

28th December 2010

- in Europe: 28/12/10 (dd/mm/yy)
- in the USA: 12/28/10 (mm/dd/yy)
- in Japan: 10/12/28 (yy/mm/dd)
- ISO 8601: 2010-12-28 (yyyy-mm-dd)

write: 0, say: oh or zero

24-hour clock	12-hour clock
07.50	(1) 7.50 am
17.30	5.30 pm
14.40	(4)
(6)	1.35 pm
05.55	(8)

24-hour clock	12-hour clock
(2)	6.30 am
15.15	(3)
(5)	4.45 pm
20.25	(7)
(9)	9.10 pm

10 Read out these times.

First, use the 24-hour clock. Then use the 12-hour clock.

1) 05.15 2) 08.50 3) 11.14 4) 13.40 5) 15.18 6) 17.30

Listening 11  Listen and add the times to the timetable in 6. Use the 24-hour clock.

12  Listen and write the correct number next to each watch.

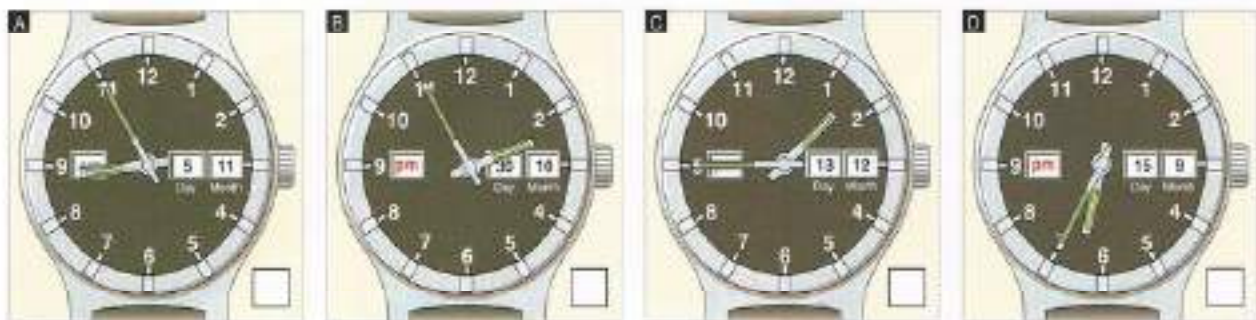

13 Read out the times and dates on the watches in 12. Use the 12-hour clock.

Social English 14 Practise this conversation. Use different days and times.

A: *When's the party?*

B: *It's on Friday.*

A: *Is that Friday the 24th?*

B: *Yes, that's right.*

A: *What time?*

B: *7.30.*

A: *OK. See you then. Bye.*

B: *See you. Bye.*



1 Naming

Start here 1  12 Listen and complete the table.

Skateboard record	Distance	Date (dd/mm/yy)
1 High jump	_____ metres	_____/_____/_____
2 Long jump	_____ metres	_____/_____/_____

Vocabulary 2 Work in pairs. Label the diagram with the words in the box.

axle deck nose plate tail truck wheel

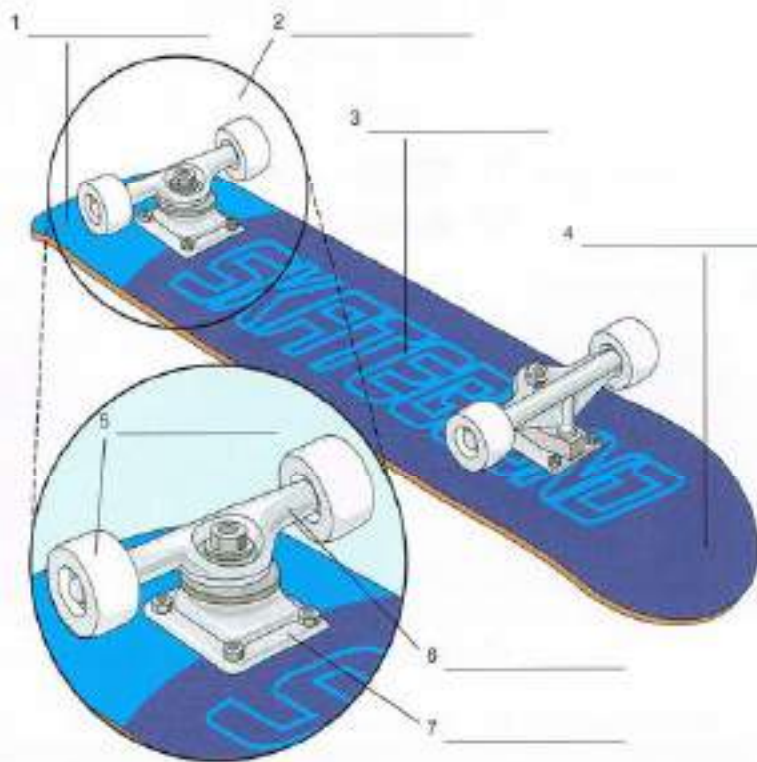

Listening 3  13 Listen and check your answers to 2.

4  14 Listen and complete the dialogue.

- What's this _____?
- It's _____ a deck.
- What's _____ called in English?
- It's called _____ truck.

Speaking 5 Work in pairs. Ask and answer questions about all the parts on the diagram.

A: What's this called? (or What's this called in English?)

B: It's called a deck.

Language

What's this called? Use this when you don't know the English word.
What's this? Use this when you don't know what it is, even in your own language.

What	's is	this that			it	's is		a	deck.
			called	?			called	an	axle.
What	are	these those			They	're are		decks.	axles.

6 Complete the dialogues with the words in the box.

It's that these They're this those

- 1 ● *What's _____ called in English?*
○ _____ called a screw.
- 2 ● *What's _____ called?*
○ _____ called a motorbike.
- 3 ● *What are _____ called in English?*
○ _____ called bolts.
- 4 ● *What are _____ called?*
○ _____ called antennas.

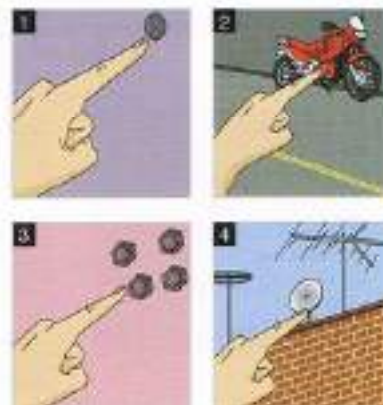

Vocabulary **7** 15 Listen and repeat.

nails ... bolts ... nuts ... spanner ... washers ... staples ... screws ... screwdriver

8 Match the words from 7 with the pictures.

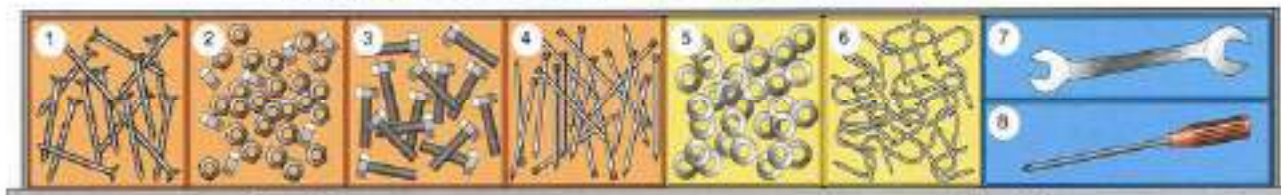

Speaking **9** Work in pairs. Ask and answer questions about the tools and fixings.

A: *What are these called?*

10 Point to things in the class or outside. Ask and answer questions.

What's this/that called? What are these/those called?

11 Work in small groups. What are these?

Clue: they're all vehicles on land, sea, in air and space.

A: *What's this?*



Answers on page 113.



2 Assembling

- Start here** 1 Work in pairs. You want to assemble a skateboard. What do you need? Choose items from page 11, exercise 7.

assemble (a skateboard) = fit the parts (of a skateboard) together

- Listening** 2  10 Listen and complete the checklist.

write: 7 mm, say *one millimetre or one mil*
write: 5 mm, say *five millimetres or five mil*
(Stress the underlined syllable)
size M5 = 5 mm

	Size	Quantity
spanner	_____ mm	1
nuts	_____ mm	_____
bolts	M_____	_____



- Speaking** 3 Work in pairs. Make dialogues with your partner.

- 1 bolts / 10 mm / 50
- 2 washers / M6 / 60
- 3 screws / 24 mm / 100
- 4 nuts / 36 mm / 75
- 5 bolts / M16 / 60
- 6 nails / 30 mil / 80

Example:

Customer: I need some bolts, please.

Shopkeeper: What size?

Customer: 10 mm.

Shopkeeper: How many?

Customer: Fifty, please.

- Task** 4 How do you assemble a skateboard? Put these diagrams in order.

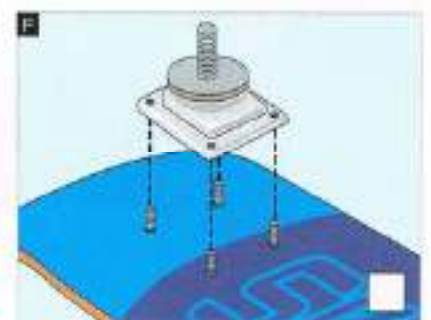
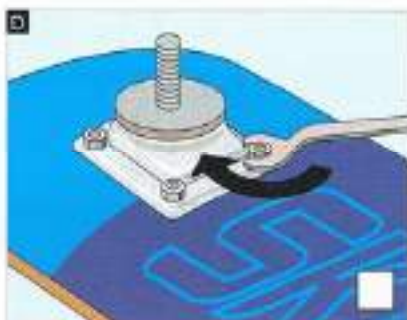
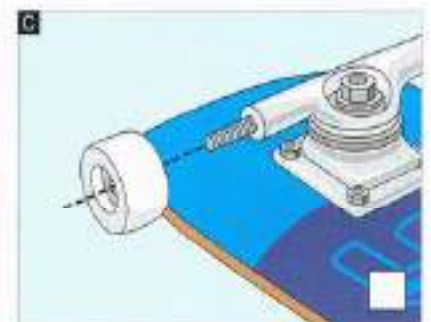
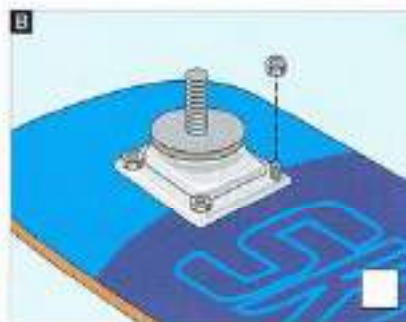
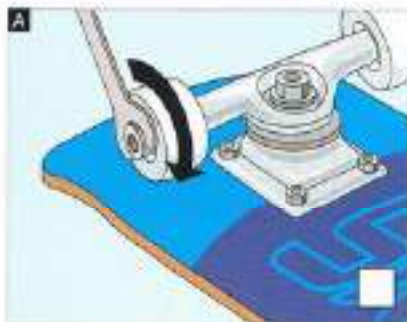

Reading 5 Read this instruction manual and check your answers to 4.

How to assemble a skateboard

- Put the plate on the four bolts.
- Put the nuts on the bolts.
- Tighten the nuts.
- Put the axle on the large bolt.
- Put the large nut on the large bolt.
- Tighten the nut.
- Put the wheels on the axle.
- Put the nuts on the axle.
- Tighten the nuts.

Language 6 Complete the table. Use the sentences from 5. Leave some spaces blank.

Verb (action)	Object (thing)	Location (place)
1 Put	the plate	on the four bolts.
2 Put		
3	the nuts.	
4 Put		
5 Put		
6		
7		
8		
9		

Vocabulary 7 17 Listen and repeat.

loosen ... pull ... push ... put ... take ... tighten

8 Complete the instructions. Use the words from 7.



- _____ the hammer on the table.
- _____ the hammer off the table.
- _____ the lever.

- _____ the lever.
- _____ the nut.
- _____ the nut.

9 Complete the table.

Verb	Opposite
put (on)	(1) _____ (off)
tighten	(2) _____
push	(3) _____

3 Ordering

Listening 1  **18** Listen to this voice mail message and complete the notes.

SKATEBOARDS HU

Phone call from

Name: Ben Phone number: 00 44

Message: Customer needs some skateboard parts. Please call him back.

2  **19** Listen and correct the mistakes in these names and numbers.

write: 55; say: five five or double 5.
write: 0; say: zero or oh.

1	Abdel Monem Waheed 00 202 47832
2	José Fernandez Luis 00 34 912 838 990
3	Adel Al-Mansour 00 971 2 605 8843
4	Nikolay Kuznetsov 00 7 495 900 22 77

Speaking 3 Work in pairs. Choose words from this unit (e.g. *screwdriver*) and dictate them to your partner.

4 Work in pairs. Leave phone messages.

Student A. Turn to page 112.

Student B:

1 Leave phone messages for Student A. Use the business cards below. Spell out the name of the person and the company.

Example:

Hello. This is John West. That's W-E-S-T. Manager of Kesko. That's K-E-S-K-O. My phone number is 00 44 1224 867 4490. Please call me back.



2 Change roles. Listen to Student A and make notes like this:

*Call from John West. Manager
Company: Kesko
Phone number: 00 44 1224 867 4490
Please call him back.*

Task 5 Work in pairs. Order goods on the phone.

Student A. Turn to page 112.

Student B:

- 1 You are a customer. You want to buy the items circled in red. Telephone Student A (the sales person) and order the items.

Skateboard accessories for sale

decks

large
medium
small

Other colours
yellow blue

helmets

large
medium
small

Other colours
red blue

pads

large
medium
small

Other colours
brown green

Item	Colour			Size			Quantity		
Helmet	red	white	blue	large	medium	small	1	2	3
Deck	red	yellow	blue	large	medium	small	1	2	3
Pad	black	brown	green	large	medium	small	2	4	6

Begin:

A: Hello. I need to buy some things for my skateboard.

B: OK. What do you need?

A: I need a helmet.

- 2 Change roles. You are the sales person. Ask Student A (the customer) what they want to buy.
- 3 When you have both finished, you can circle new items and phone up to order them.



USEFUL PHRASES

What size/How many/What colour do you need?
What's your name? Please spell that.
What's your phone number?

Social English

- 6** **20** Listen and then introduce yourself and your partner to other students.

A: I'm Luis. I'm a student. And this is Paulo. He's a student, too.

B: Hello, Luis. Hello, Paulo. Nice to meet you.

Review Unit A

1 Rewrite these statements as questions.

1 The machine's on.

Is the machine on?

2 The switches are off.

3 Roberto's in London.

4 They're IT technicians.

5 He's a student.

6 She's Polish.

2 Answer the questions in the negative. Then make a positive statement.

1 Is it Sunday today? (Monday)

No, it isn't Sunday today. It's Monday.

2 Is the power on? (off)

3 Are you Peter? (John)

4 Are they from Berlin? (Bonn)

5 Is she a technician? (engineer)

6 Is he an electrician? (builder)

3 Rewrite these sentences using contractions where possible.

1 My name is Jamal and I am from Jordan.

My name's Jamal and I'm from Jordan.

2 This is Jean. He is French, but he is not from Paris.

3 This is Frieda. She is from Rome, but she is not Italian.

4 Look at the switch. It is down, but the power is not on.

5 These are the wrong items. They are not bolts. They are screws.

6 What is this tool called? What are these called?

- 4 Complete the questions and answers with the words in the box. You can use the words more than once.

am are do does is

- | | |
|--------------------------------------|---------------------------------|
| 1 Where <u>are</u> you from? | a) No, my name _____ Jan. |
| 2 What _____ you do? | b) I _____ an IT technician. |
| 3 Excuse me. _____ you Ian? | c) His name _____ Peter. |
| 4 What _____ he do? | d) No, they _____ from Germany. |
| 5 What _____ his name? | e) I <u>am</u> from Denmark. |
| 6 Excuse me. _____ they from France? | f) He _____ a marine engineer. |

- 5 Match the questions with the answers in 4.
 6 Work in pairs. Practise the questions and answers in 4. Use contractions.
 7 Look at the pictures in Units 1 and 2. Work in pairs. Make questions and answers about the pictures.

*What's this/that called? What are these/those called?
 It's/They're called*

- 8 Look at this drawer for 15 seconds. Then close the book and list everything in the drawer.

Begin: 3 screws, ...

- 9 Draw a line from each word to its opposite.

on stand large in stop off
 left small up closed sit right
 open out
 start tighten loosen down

- 10 Choose the correct way to read out these numbers.

- 1 Room 101
 a) one hundred and one
 b) one oh one

101

- 2 Height: 8850 metres
 a) eight thousand eight hundred and fifty
 b) double eight five oh



- 3 Tel: 74 77 88
 a) seventy-four seventy-seven eighty-eight
 b) seven four double seven double eight

74 77 88

- 4 Voltage: 109,845 V
 a) One hundred and nine point eight four five
 b) One hundred and nine thousand eight hundred and forty-five

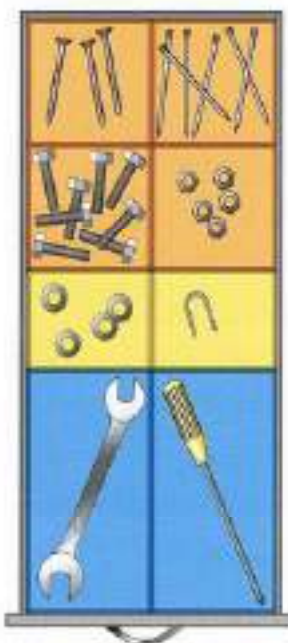

- 11 Work in pairs. Solve this puzzle. Write a sentence of eight words.

pea	are		see	tea	eye			why	oh	you	are		
P		A				S	E						
E	N	G	L	eye	I	S	H	E	V	E	are	why	
											D	A	why
W	eye	tea			A	F	are	eye					
			H						E	N	D		

- 12 Complete the dialogue with the question words in the box.

How What What's

- | | |
|--|---|
| 1 ● _____ do you need?
○ <i>Some bolts, please.</i> | 4 ● _____ colour? Black or silver?
○ <i>Black, please.</i> |
| 2 ● _____ many do you need?
○ <i>Forty, please.</i> | 5 ● _____ your name?
○ <i>John Martins.</i> |
| 3 ● _____ size?
○ <i>10 mm, please.</i> | 6 ● _____ your phone number?
○ <i>It's 00 30 438 9981.</i> |

- 13 Say the dates and times. Use the 12-hour clock.

1 WED 10/04/07 13.40	3 MON 03/09/10 11.05
2 FRI 13/11/09 07.55	4 WED 29/01/11 21.32

Example: 1 Wednesday, the tenth of April 2007 at 1.40 pm.

- 14 Complete the number sequences with your partner.

- a) 1, 2, 3, 5, 7, _____, _____, _____
 b) 1, 1, 2, 3, 5, 8, _____, _____, _____
 c) 2, 5, 10, 17, 26, _____, _____, _____
 d) 0, 1, 10, 11, 100, 101, _____, _____, _____

- 15 Write these numbers and units in words.

- 1 5 km five kilometres
 2 250 kg _____
 3 €1015 _____
 4 110 V _____
 5 0°C _____
 6 13 mm _____

- 16 Look at the pictures on page 113 for 15 seconds. Don't look again. Are these true (T) or false (F)?

- | | |
|---------------------------------|-------------------------------------|
| 1 The window is open. T/F | 7 The large helmet is green. T/F |
| 2 The TV is on. T/F | 8 The small helmet is red. T/F |
| 3 The white switch is up. T/F | 9 The cable is under the table. T/F |
| 4 The black switch is down. T/F | 10 The car goes left. T/F |
| 5 The circle is blue. T/F | 11 The letter is B. T/F |
| 6 The triangle is yellow. T/F | 12 The number is 14. T/F |

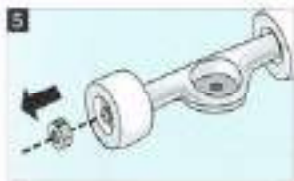

17 Complete the instructions for these pictures. Use **SOME** of the words in the box.

loosen off on put take tighten use

How to take the truck off the skateboard

Step 1: (a) _____ the large nut. (b) _____ the large spanner.

Step 2: (c) _____ the large nut (d) _____ the bolt.

Step 3: (e) _____ the truck (f) _____ the bolts.

How to take the wheels off the truck

Step 4: (g) _____ the small nuts. (h) _____ the small spanner.

Step 5: (i) _____ the small nuts (j) _____ the axle.

Step 6: (k) _____ the wheels (l) _____ the axle.

18 Put the words in the instructions in the correct order.

1 screws the tighten

Tighten the screws.

2 the large hammer use

3 take off the car the old wheel

4 the new wheel put on the car

5 into the wood hammer the nails

6 through the holes the bolts push

Project 19 Find the meaning of the words *plate*, *truck* and *axle* for different technical fields, and write the results in a table.

Search results for deck	Technical field
a floor or level of a ship	marine engineering
a floor or level of a bus or other vehicle	transport engineering
an outdoor floor attached to a building	building and construction
the road surface of a bridge	civil engineering
cement or tile area around a swimming pool	building and construction
flat surface of a skateboard	sports technology
flight deck – surface on an aircraft carrier	aerospace
component of music system – e.g. turntable, cassette deck	electronics
computer games console	IT, entertainment industry

1 Tools

Start here 1  21 Listen and complete the TV advert.

This is the new Multi Tool!

Use it at home. Use it on the building site. Use it when you travel.

It has a (1) _____ and a pair of (2) _____.

It also has a (3) _____, a (4) _____ and a

(5) _____.

The Multi Tool has everything you need! Only £29.99. Buy one now!



Listening 2  22 Listen and complete the dialogue with the words in the box.

do does doesn't have

- Do you (1) _____ a Multi Tool?
- Yes, I (2) _____.
- Does the Multi Tool (3) _____ a hammer?
- Yes, it (4) _____.
- Does it (5) _____ a pair of scissors?
- No, it (6) _____.

3  23 Listen and repeat.

a pair of pliers ... a pair of scissors ... a blade ... a can opener ...
a bottle opener ... a screwdriver

pliers and scissors are always plural
say: I need some scissors, or
I need a pair of scissors.

Language

Do	you	have	a Multi Tool?	Yes, I do. / No, I don't.
Does	the Multi Tool		a hammer?	Yes, it does. / No, it doesn't.
	The Multi Tool	doesn't does not	have a hammer.	

4 Work in pairs. Practise the dialogue.

- A: Does Pedro have a Multi Tool? Bob / you / we
B: Yes, he does. he / I / we
A: Does it have a ruler? chisel / saw / spanner / screwdriver
B: No, it doesn't. yes / no
A: Does it have a pair of pliers? hammer / scissors / opener / blade
B: Yes, it does. no / yes

5 Work in pairs. Design a Multi Tool for your work.

- Reading 6** Complete the labels for this tool.
7 Read this product review and check your answers to 6.

Product review: Survival Tool
 This tool has a ruler, a screwdriver, a pick and a blade. It also has two openers. One opens cans. The other opens bottles. It has two wrenches. It doesn't have a saw. And it doesn't have a hammer, because the tool is too small. It has a plastic cover. The cover comes in three colours: black, blue or red.

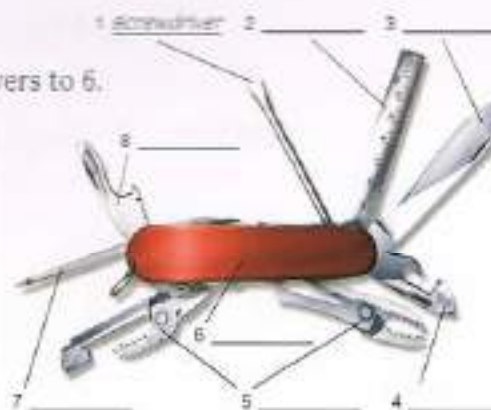

- Speaking 8** Ask and answer questions about the Survival Tool and the Multi Tool. Use the words in the box.

blade can opener cover hammer pair / pliers pair / scissors ruler wrenches

- A: Does the Survival Tool/Multi Tool have ... ?
 B: Yes, it does. / No, it doesn't.

- Vocabulary 9** Match the parts to the words.
 handle, shaft, head, blade, jaws



- 10** Draw some tools that you use in your work. Label some parts with words from 9. Then make sentences.
This is a ... It has a handle, a head and two jaws.

- Speaking 11** Compare these three products.



Product comparison			
	Survival Tool	Multi Tool	Key Tool
knife blade	•	•	•
saw		•	•
screwdriver	•		•
bottle opener	•	•	•
can opener	•	•	
ruler	•		
pick	•		
wrench	•		
hammer		•	
pliers		•	•

- 1 The Key Tool has a screwdriver, but it doesn't have a wrench.
 2 The Survival Tool has a ruler, but the Multi Tool doesn't.

- Writing 12** Write a short comparison of the three products in 11.

2 Functions

Start here 1 Match the words with the pictures.

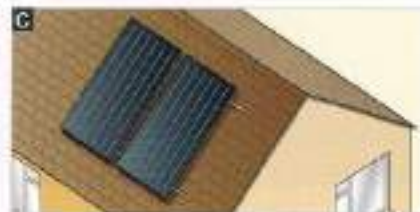
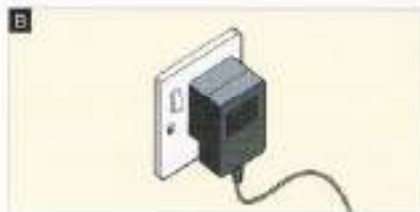

Electrical power sources

- 1 mains electricity + AC adapter
- 2 solar power
- 3 dynamo
- 4 batteries

Reading 2 Label the photos of the emergency radio below with the words in the box.

alarm antenna clock compass handle thermometer torch

3 24 Listen and repeat.

handle ... thermometer ... torch ... alarm ... clock ... compass ... antenna

4 Read the description and check your labels.

internal → external

Dynamo Solar Radio

1 clock

2 _____

3 _____

4 _____

5 _____

6 _____

7 _____

Key features: This equipment has

- a radio
- a thermometer
- a compass
- a torch
- a clock
- an alarm

Power sources

It uses electricity from four sources of power:

- an AC adapter. This connects the mains electricity supply to the radio.
- 3 external AA batteries.
- a solar panel. This changes the Sun's energy into electricity and charges an internal battery.
- a dynamo generator. The handle turns the dynamo. The dynamo produces electricity and charges the internal battery.

5 Explain the function of these parts.

- | | |
|------------------|-------------------|
| 1 the AC adapter | 3 the dynamo |
| 2 the handle | 4 the solar panel |

6 Match the parts with their functions.

Part	Function
1 thermometer	a) shine a light
2 compass	b) make electricity
3 torch	c) turn the dynamo
4 clock	d) tell the time
5 alarm	e) find North
6 solar panel	f) receive radio signals
7 handle	g) measure temperature
8 antenna	h) make a loud noise

7 Make sentences from the parts and functions in 6.

Example: 1 The thermometer measures temperature.

Language	It	measure	s	temperature.	
Does	it	measure		temperature?	Yes, it does. / No, it doesn't.
	it	does not doesn't	measure	speed.	

Speaking

8 Work in pairs. Make questions and answers, using the words from 6.

A: *Does a thermometer measure time?*
B: *No, it doesn't. It measures temperature.*

9 Match the pictures with the verbs in the box.

cut drive in grip loosen tighten



10 Make sentences.

A spanner		nails.
Pliers		bolts and wire.
A screwdriver	cut(s)	nuts and bolts.
A chisel	grip(s)	paper and string.
Scissors	drive(s) in	screws.
A saw	tighten(s) and loosen(s)	wood.
Hammers		wood and metal.

Social English

11 Make a list of job titles useful to you. Use a dictionary.

Examples: marine technologist, computer operator, automotive engineer, architectural technician

12 Find out about other students in your class.

A: *What do you do?*

B: *I'm a/an ... (student/builder/mechanic ...)*

A: *Where do you study/work?*

B: *I study/work at ... (name of school/college/company ...)*

A: *What does ... do?*

B: *He/She's a/an ... He/She works at ...*

3 Locations

Start here 1  25 Listen to this computer lesson. Complete the dialogue with the words in the box.

at bottom on left right top

- OK, now put the cursor on the *START* button.
- Where's the *START* button?
- It's _____ the _____. On the _____. Do you see it?
- Yes. Is that it?
- Yes, that's correct. ... Now, move the cursor up to the *CLOSE* button.
- Where's that?
- It's an *X*. It's _____ the _____. At the _____.
- Is that it?
- Yes, that's it. Now click.

Vocabulary

middle = centre
BrE centre, AmE center

2 Match the TV monitors with their locations.

- 1 bottom left ____
- 2 bottom right ____
- 3 centre bottom ____
- 4 centre left ____
- 5 centre right ____
- 6 centre top ____
- 7 top left ____
- 8 top right ____
- 9 centre ____



Language **in** in the middle, in the centre
at at the top, at the bottom
on on the left, on the right

Reading 3 Correct this description. There are six mistakes in location.



Here is one way to set up your computer station. Put your screen in the centre of the system. Then put one speaker in the centre on the left, and put the other speaker in the centre on the right. Put the scanner at the top on the left, and put the computer at the top on the right. Then put the DVD drive at the top in the middle and put the printer at the bottom on the left. Finally, put the keyboard at the bottom on the right, and put the mouse at the bottom in the centre.

- Language** 4 Look again at the computer station in 3. Are these statements true or false?
- 1 The computer is *at the top, on the left*. T/F
 - 2 The computer is *above* speaker 1. T/F
 - 3 The computer is *to the left of* the printer. T/F

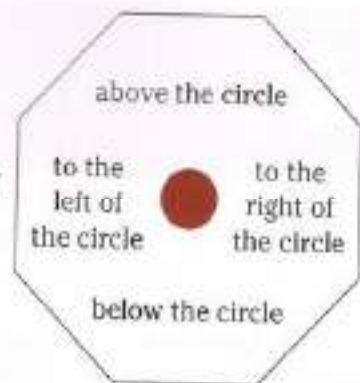

- 5 Look at the diagram. When do we use *ON the left* and when do we use *TO the left OF*?
- 6 Complete the sentences about the computer station in 3 with the words in the box.

above at below of in on to

- 1 The printer is _____ the top, _____ the middle.
The scanner is _____ the right _____ the printer.
The screen is _____ the printer.
 - 2 The mouse is _____ the bottom, _____ the right.
The keyboard is _____ the left _____ the mouse.
Speaker 2 is _____ the mouse.
- 7 Look again at the computer station in 3. Make sentences about the location of:
- 1 the mouse
 - 2 the DVD drive
 - 3 the scanner
 - 4 the screen

- Task** 8 Work in pairs. Student A. Turn to page 113.

Student B:

- 1 Answer Student A's questions. Use phrases from exercise 6.
- 2 Ask Student A where these items are and write them in their correct locations: *mouse pads, scanners, CD-ROMS, adapter, printers, amplifiers, TV.*

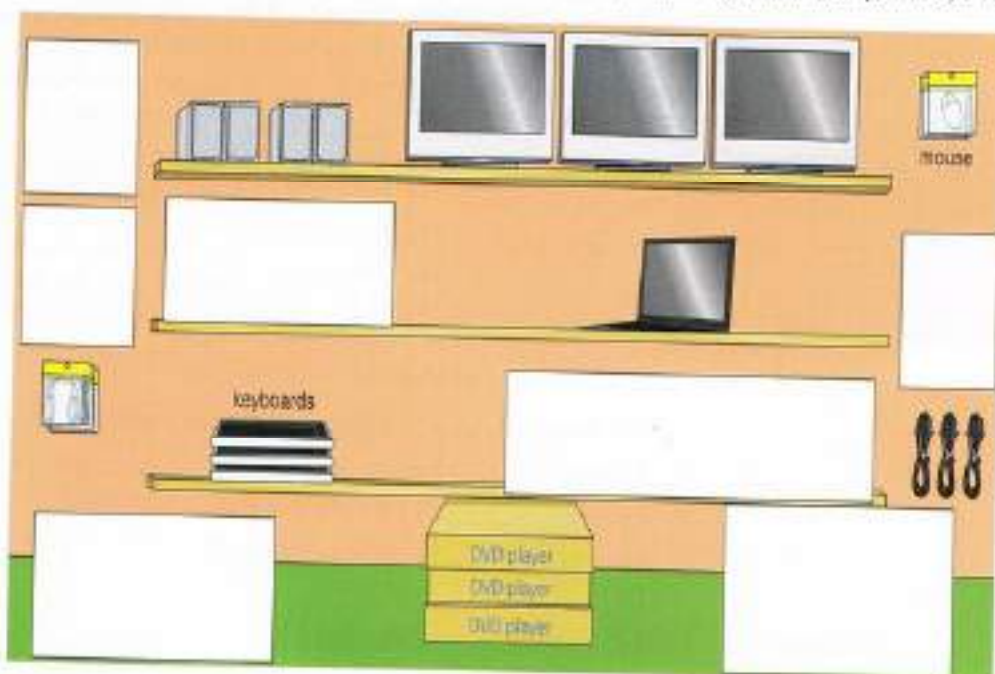

shelf (singular); shelves (plural)

Start here

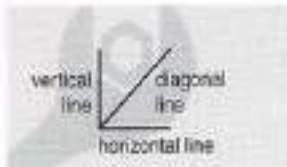

1 Directions

- 1 Label the jetpack man's movements with the words in the box.

backwards down forwards sideways up

- 2 Work in pairs. Which directions can planes and helicopters fly? Tick the boxes.

Direction	Plane	Helicopter
forwards		
backwards		
up and down		
sideways		



- Reading 3 Read the text. Check your answers to 2.

Passenger planes can fly forwards, and can turn to the left and to the right. But they cannot fly backwards or sideways. They can fly diagonally up and down, but they cannot fly straight up or straight down.

Helicopters can fly forwards, straight up and down, sideways and backwards.

Planes and helicopters can both rotate. Planes and helicopters can rotate on their horizontal axis. Helicopters can also rotate on their vertical axis.

Language

	It	can	fly	sideways.	
	They	can't/cannot			
Can	it		fly	sideways?	Yes, it can. / No, it can't
	they				Yes, they can. / No, they can't

- 4 Complete these sentences with *can* or *can't*.

- A helicopter _____ fly sideways, but a plane _____
- A plane _____ fly sideways, but it _____ fly forwards.
- A plane _____ fly straight up, but a helicopter _____
- A plane _____ fly straight up, but it _____ fly diagonally.

- Speaking 5 Work in pairs. Practise dialogues.

helicopter(s) / rocket(s) / plane(s) / fly sideways / fly straight up / fly diagonally up / rotate

- A: *Can a plane fly forwards?* B: Yes, it can.
A: *Can it fly backwards?* B: No, it can't.

Task 6 Work in pairs. Follow the instructions and answer the questions.

Close your fist and hold your arm out straight in front of you.

- 1 Think of your wrist. (Don't move it). How many directions can it move in? One, two, three or four?
- 2 Think of your shoulder. (Don't move it). How many directions can it move in? One, two, three or four?
- 3 Think of your elbow. (Don't move it). How many directions can it move in? One, two, three or four?

Reading 7 Read the text. Check your answers to 6.



The human arm can move in seven different directions. The arm has three pivots: the wrist, the elbow and the shoulder. The wrist can move in three different directions. At the wrist, the hand can move up and down about 90° , it can move from side to side about 70° , and it

can rotate about 180° . The shoulder can move in the same three directions, but different angles. It can rotate about 20° . The elbow can only move in one direction. At the elbow, the forearm can only move up and down. It cannot move sideways or rotate.

8 Match each movement in the diagram in 7 with a word or phrase from the box.

rotate move sideways move up and down

Listening 9 26 Listen and choose the correct answers.

- | | |
|-------------------------------|---------------------------------|
| 1 a) 19° b) 90° | 3 a) 17° b) 70° |
| 2 a) 14° b) 40° | 4 a) 118° b) 180° |

Task 10 Work in groups. Look at the diagram in 11 and answer these questions.

- 1 How many directions can this robot arm move?
- 2 Which part of the robot arm has different movements from the human arm. Is it: a) the shoulder? b) the wrist? c) the elbow?

Language 11 Complete the text about the robot arm with the words in the box.

can can't has is isn't

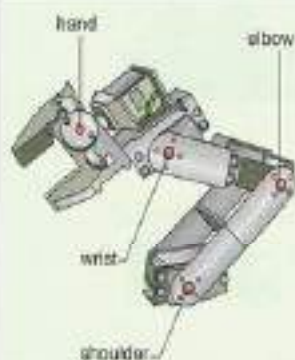

This robot arm (1) _____ like a human arm. It (2) _____ a 'wrist', an 'elbow' and a 'shoulder'.
 The 'wrist' (3) _____ like the human wrist. It (4) _____ three movements. It (5) _____ rotate. It (6) _____ move from side to side. It (7) _____ move up and down.
 The 'elbow' (8) _____ like the human elbow. It (9) _____ one movement. It (10) _____ move up and down.
 The 'shoulder' (11) _____ like the human shoulder, because it only (12) _____ two movements. It (13) _____ rotate, and it (14) _____ move up and down. But it (15) _____ move sideways.

2 Instructions

Start here 1 Try this quiz. Choose the correct answer.

km/h = kilometres per hour
(used by most countries)
mph = miles per hour (used
in some countries, including
the US and UK)
m/s = metres per second
rpm = revolutions per minute;
1 revolution = 1 rotation of
360°

What are the speeds?

- 1 Rotation of a fast CD-ROM?
a) 98,000 rpm b) 9800 rpm
- 2 The speed of sound?
a) 746 km/h (464 mph) b) 1200 km/h (746 mph)
- 3 The maximum speed on land?
a) 1228 km/h (763 mph) b) 1228 mph (1976 km/h)
- 4 The maximum speed on water?
a) 154 m/s b) 154 mph c) 154 km/s
- 5 The rotation of the Earth?
a) 1000 mph (1609 km/h) b) 1000 km/h (621 mph)
- 6 The Earth moving around the Sun?
a) 67,000 mph (107,825 km/h) b) 67,000 km/h (41,631 mph)

- Listening** 2  27 Listen and check your answers to 1.
3 Work in pairs. Write down some speeds. Dictate them to your partner.
- Vocabulary** 4 Label the diagram with the words in the box.

antenna handle joysticks slider switch

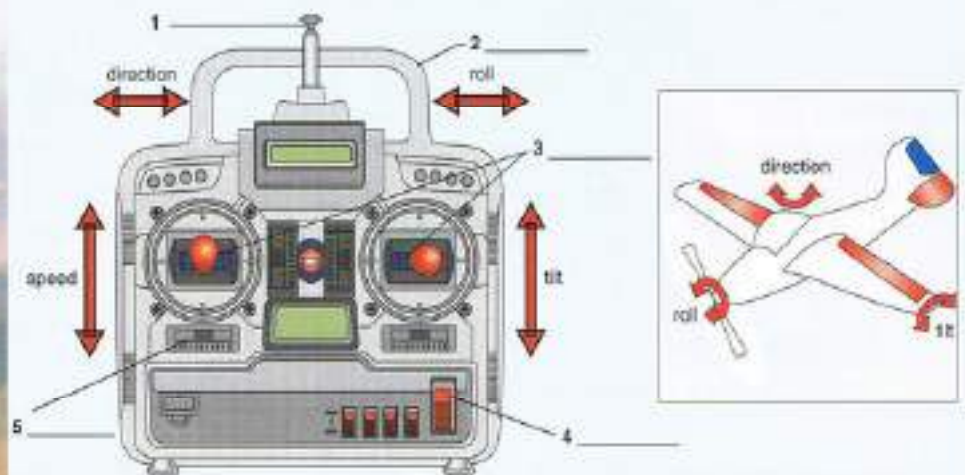

Task 5 Work in groups. What do you think the plane does when you move these controls?

Look at the joystick on the left.

- 1 Push it up (away from you). Pull it down (towards you). What happens?
- 2 Push it to the left. Push it to the right. Now what happens?

Look at the joystick on the right.

- 3 Push it up. Pull it down. What happens?
- 4 Push it to the left. Push it to the right. Now what happens?

3 Actions

Start here 1 Look at the diagrams and answer the questions.

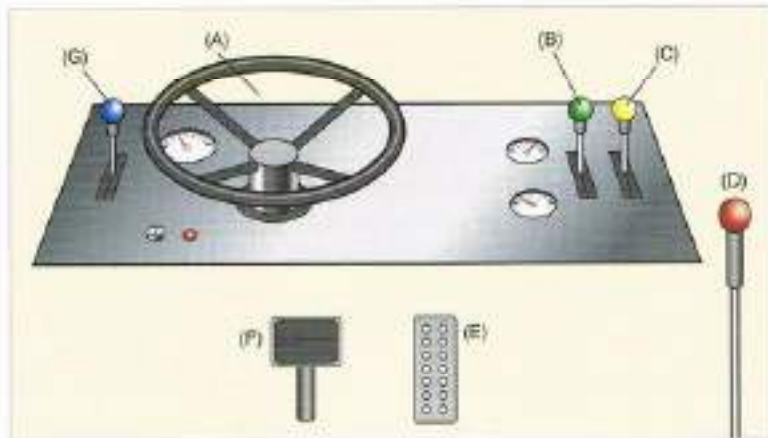

- 1 How many pedals does it have?
- 2 How many levers does it have?
- 3 Is the steering wheel on the left or on the right?

Reading 2 Read the manual. Write the letters (A-G) from the diagram next to the controls.

reverse = go backwards

In the diagram, you can see the controls of the forklift truck. On the left is a lever. This is the direction lever (1 _____). Push this lever forwards, and the truck moves forwards. Pull it backwards, and the truck reverses. Next you can see the steering wheel (2 _____). This turns the truck to the left and right. At the top, on the right, you can see two levers. Push the left-hand lever (3 _____) forwards, and the fork moves up. Pull it back, and the fork moves down. Push the right-hand lever (4 _____) forwards, and the fork tilts up. Pull it back, and the fork tilts down. At the bottom, on the right, you can see a lever. This is the parking brake (5 _____). At the bottom, you can see two pedals. The LH pedal is the brake (6 _____). The RH pedal is the accelerator (7 _____).

3 Describe these movements of the truck. Use words from the manual.

Example: A. The fork tilts down.

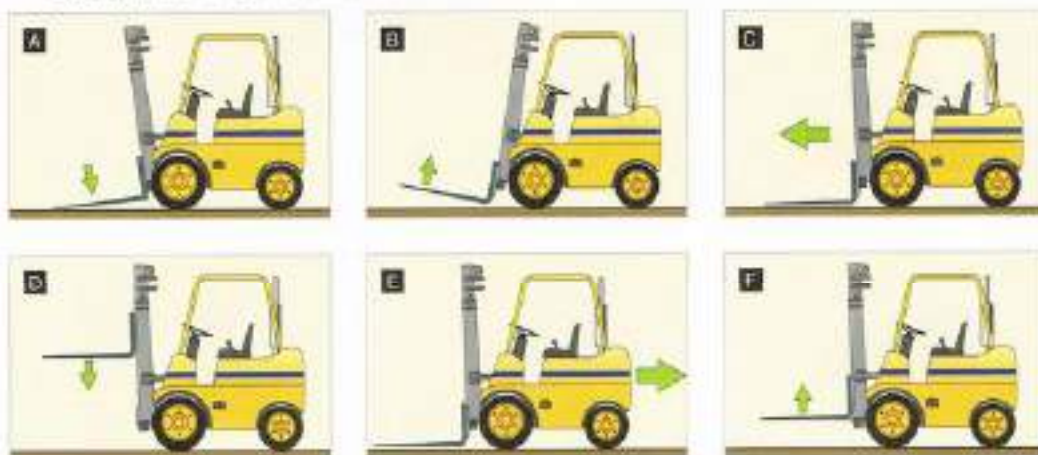

Speaking 4 Work in pairs. Have a driving lesson.

Student A: You are the driving instructor. Give instructions.

Student B: You are learning to drive. Follow the instructions. Act them out.

Drive forwards. Reverse. Go slowly. Go faster. Slow down. Stop! Turn left. Turn right. Reverse to the left. Reverse to the right. Turn round. Do a U-turn. To the left. To the right.

turn round = do a U-turn

Writing 5 Write a short set of instructions for one of these jobs. Draw a diagram.

- 1 How to park a car.
- 2 How to dock a small sailing boat.
- 3 (Choose your own job.)

6 Write full sentences from these notes. Use **when** and **you** and add **the** and punctuation.

- 1 pull lever C backwards → fork tilts down
- 2 push lever B forwards → fork moves up
- 3 turn steering wheel to the right → truck turns right
- 4 pull lever G backwards → truck reverses
- 5 press brake pedal → truck stops
- 6 press accelerator → truck goes faster

Example: 1 When you pull lever C backwards, the fork tilts down.

Task 7 Work in pairs. Have a driving lesson for the forklift truck.

Student A. Turn to p. 115.

Student B:

- 1 You're the driving instructor for the forklift truck. Student A is learning to drive the truck. Tell Student A to follow these instructions in the correct sequence.
- 2 Then change roles. Follow Student A's instructions and rearrange your pictures into the correct sequence.

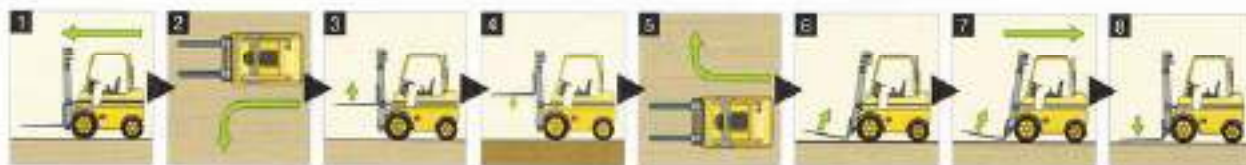

The correct sequence of the instructions is:

--	--	--	--	--	--	--	--

Review Unit B

1 Rewrite these statements as questions.

- 1 John has the spanners. Does John have the spanners?
- 2 The students have a holiday tomorrow. _____
- 3 The Multi Tool has a screwdriver. _____
- 4 These bikes have strong brakes. _____
- 5 The radio has an internal battery. _____
- 6 Those houses have solar panels. _____

2 Answer the questions in the negative. Then make a positive statement.

- 1 Do you have a car? (motorbike)
No, I don't have a car. I have a motorbike.
- 2 Does your brother have a DVD? (VCR)

- 3 Does the Multi Tool have scissors? (knife blade)

- 4 Do we have English today? (Science)

- 5 Does your radio have batteries? (dynamo)

- 6 Do the pliers have plastic handles? (metal handles)

3 Rewrite these sentences using contractions where possible.

- 1 The Multi Tool does not have a wrench. It is not very useful.
The Multi Tool doesn't have a wrench. It isn't very useful.
- 2 We do not have an AC adapter. We can not switch on the computer.

- 3 I am a technician, but I do not have my tools here. I can not repair your TV.

- 4 The electricity is off, and we do not have any batteries. You can not use the radio now.

4 Give short answers.

- 1 Can you swim? (No) No, I can't.
- 2 Is he an IT technician? (No) _____
- 3 Does the DVD work now? (Yes) _____
- 4 Do your friends have tickets for the cinema? (No) _____
- 5 Are you a technology student? (Yes) _____
- 6 Does your radio have a solar panel? (No) _____
- 7 Are you a telecoms engineer? (No) _____
- 8 Can planes rotate on a horizontal axis? (Yes) _____

5 Complete the dialogue with the correct form of the verbs in brackets.

- Look at my radio. Do you like it?
- Yes, it's great. What (1) _____ (do) that handle (2) _____ (do)?
- It (3) _____ (turn) a dynamo. The dynamo (4) _____ (produce) electricity for the radio.
- What are those, at the top?
- They're solar panels. They (5) _____ (charge) the internal battery on a sunny day.
- Can the radio also (6) _____ (use) mains electricity?
- Yes, it can. And it also (7) _____ (use) AA external batteries.
- So your radio (8) _____ (have) four power sources!
- That's right.

6 Label the parts with the words in the box.

blade/blades handle/handles head jaws shaft

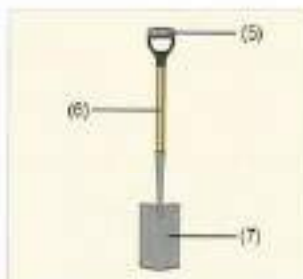
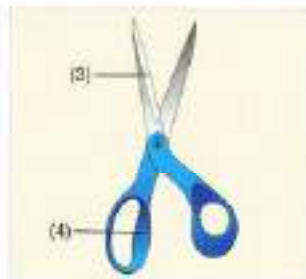
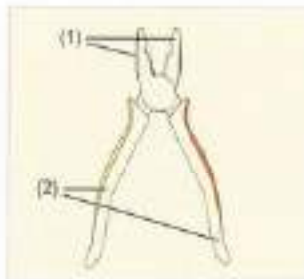

7 Describe the tools in 6.

Example: 1. A pair of pliers has two handles and two jaws.

8 Look at this toolboard for 15 seconds. Then close the book and list all the tools.

Begin: Five screwdrivers. They're at the top, on the left.

9 Look again at the toolboard on the right. Make sentences with the words in the box.

above below to the left of to the right of

Example: The screwdrivers are to the left of the spanners and above the hammer.

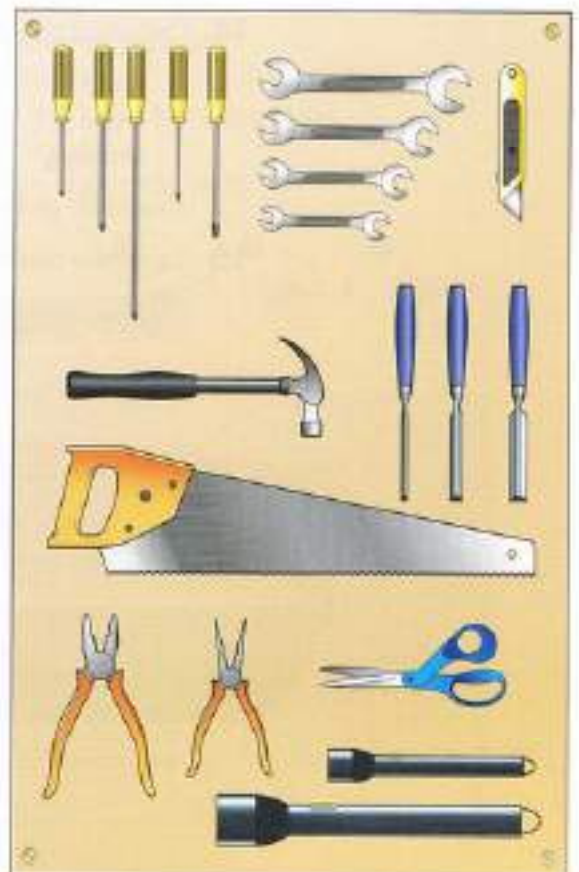

10 Guess the device from its description.

- 1 This item covers the head and protects it. Skateboarders use it.
- 2 This tool has handles and jaws. It can grip nuts and bolts. It pulls nails out.
- 3 This equipment converts (or changes) sunlight into electricity.
- 4 You rotate these items onto bolts. You tighten them with a spanner.
- 5 This item receives radio and TV signals. You can see it on a house or car.
- 6 This equipment produces electricity when it rotates.

11 Complete these questions and answers with the words in the box.

am are come/comes do does is study/studies work/works

- | | |
|-------------------------------|--------------------------------------|
| 1 Where <u>are</u> you from? | a) She _____ at Vodafone. |
| 2 What _____ you do? | b) I _____ a student. |
| 3 Where _____ you study? | c) She _____ a technician. |
| 4 What _____ your subject? | d) She _____ from Finland. |
| 5 Where _____ Elli come from? | e) I <u>am</u> from Japan. |
| 6 _____ she a student, too? | f) I _____ at the Technical College. |
| 7 What _____ she do? | g) I _____ telecoms engineering. |
| 8 Where _____ she work? | h) No, she _____ not. |

12 Match the questions with the answers in 11.

13 Work in pairs. Practise the questions and answers in 11. Use contractions where possible.

Example: 1-e A: Where are you from? B: I'm from Japan.

14 Cross out the silent letters in the words below. Say the words.

- | | | |
|------------|------------|-----------|
| 1 knife | 4 scissors | 7 descend |
| 2 build | 5 wrist | 8 right |
| 3 building | 6 ascend | 9 tighten |

Example: ~~w~~rench

15 Label the controls with the words in the box.

button display key lever pedal slider switch wheel

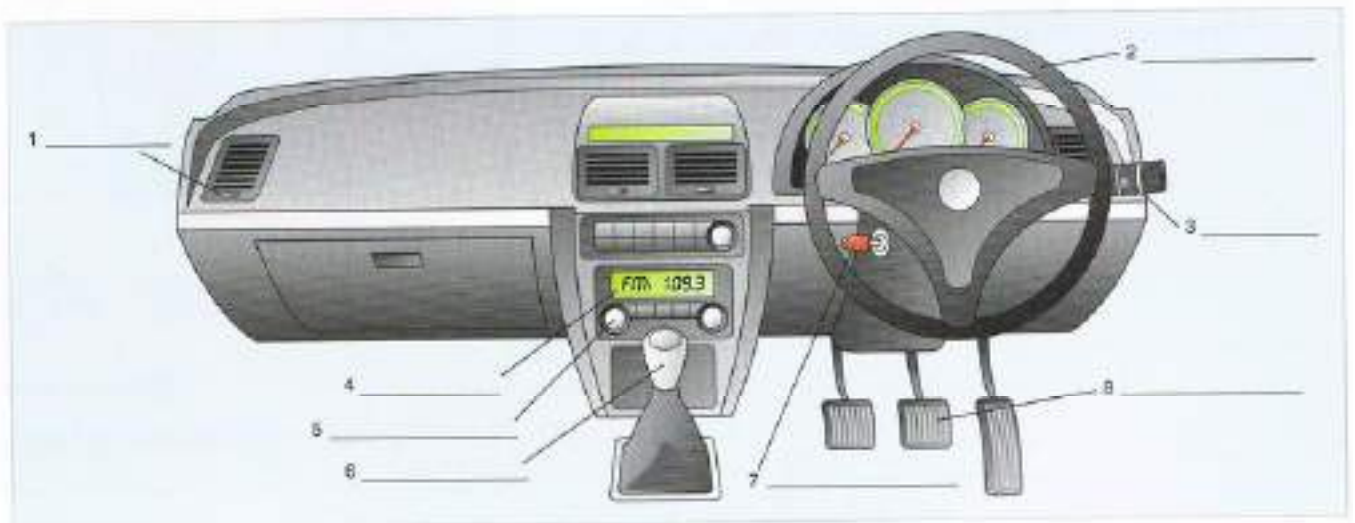

16 Put **a**, **an**, **some** or **a pair of** before each item.

To buy:

_____ printer _____ AC adapter _____ speakers _____ keyboard _____ amplifier
 _____ headphones _____ earphones _____ nuts _____ bolts _____ pliers

17 Make positive and negative statements.

- 1 this opener ... open bottles ✓ open tins ✗
- 2 these wrenches ... tighten the M12 bolts ✗ loosen the M5 nuts ✓
- 3 that antenna ... receive radio signals ✓ transmit them ✗
- 4 a rocket ... fly straight up ✓ reverse ✗
- 5 passenger planes ... fly sideways ✗ turn left and right ✓
- 6 I ... drive a car ✓ operate a forklift truck ✗

Example: *I This opener can open bottles, but it can't open tins.*

18 Follow the instructions.

Start at the red triangle. Move sideways three boxes to the right. Go diagonally up one box to the right. Move horizontally eight boxes to the left. Descend vertically three boxes. Go diagonally up two boxes to the right. Move diagonally down two boxes to the right. Where are you?



19 Match pictures with the instructions below.

- 1 Fly diagonally down.
- 2 Fly forward.
- 3 Fly straight up.
- 4 Reverse.
- 5 Rotate on a vertical axis.
- 6 Reverse to the left.
- 7 Turn left.
- 8 Rotate on a horizontal axis.
- 9 Turn right.
- 10 Reverse to the right.

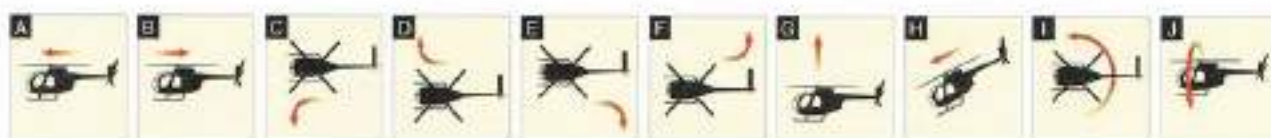

Projects 20 Make a list of job titles in your industry.

Example: *Construction Industry: structural engineer, quantity surveyor, site manager, architectural technician, etc.*

21 What do these word parts mean? Find other words with the same part.

Word part	Meaning of word part	Example of word	Meaning of word
multi-		1 multimedia	1
		2	2
therm-		1 thermometer	1
		2	2
kilo-		1 kilometre	1
		2	2

1 Heating system

- Start here** 1 Work in groups. Which way does the water flow in this system? Draw arrows to show the direction of the flow.

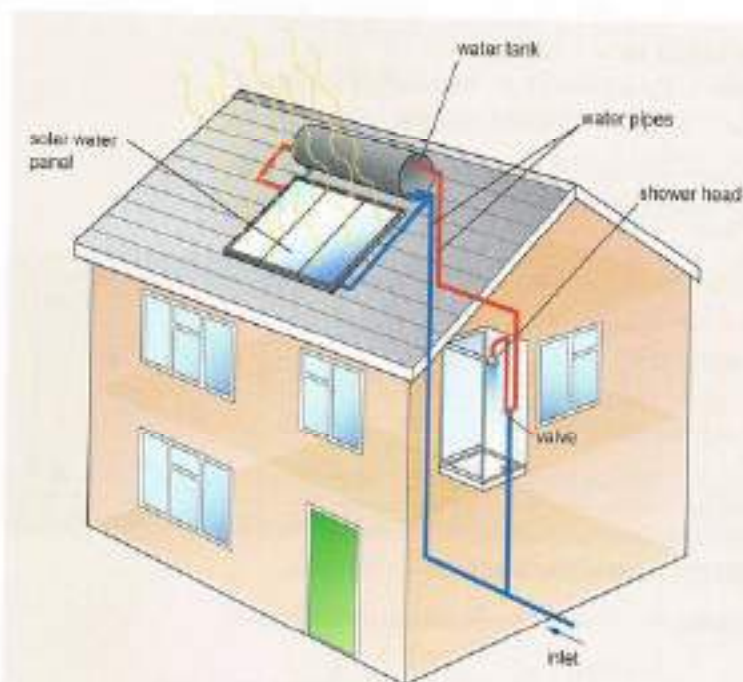
**Solar water heater**

The main parts of this system are water pipes, a solar water panel, a water tank, an inlet, a valve and a shower head. The tank is above the solar panel.

- 5 Cold water enters the system through the inlet. It then flows into the tank. From here, the water flows into the solar panel.

The Sun heats the water in the panel.

- 10 The hot water rises and flows from the panel into the tank. In the tank, hot water stays at the top and cold water sinks to the bottom.

- 15 When you open the valve, hot water flows from the tank, through the valve, to the shower head. Here, it finally leaves the system.

- Reading** 2 Read the text. Check the directions of your arrows in 1.
3 What do these words refer to?

- | | | | |
|------------------|----------------|---------------|----------------|
| 1 It (line 6) | a) inlet | b) cold water | c) system |
| 2 here (line 7) | a) tank | b) inlet | c) water |
| 3 Here (line 16) | a) tank | b) valve | c) shower head |
| 4 it (line 16) | a) shower head | b) valve | c) hot water |

Example: 1 Cold water enters the system through the inlet. It then ...
In line 6, it refers to cold water.

- 4 Draw the flow chart, putting these boxes into the correct order.

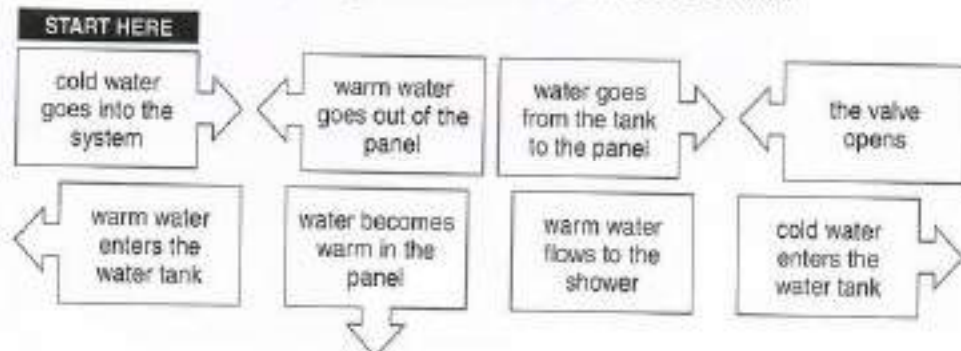

Language

The water	flow	-S	into the tank.
	move		out of the tank.
	go	-BS	through the pipes.
	pass		around the solar panel.
The electron	flow	-S	to the outlet.
	go		from the inlet.
	flow	-S	around the circuit.
	go		through the cables.

Vocabulary

5 Label the diagrams 1-6 with the prepositions in the box.

around from into out of through to



1 _____ 2 _____



3 _____



4 _____



5 _____

Task

8 Work in pairs. Explain your system to your partner.

Student A. Turn to page 114.

Student B:

- 1 Listen to Student A, and ask questions. Then draw a simple diagram of his/her system.
- 2 Explain your system to Student A.

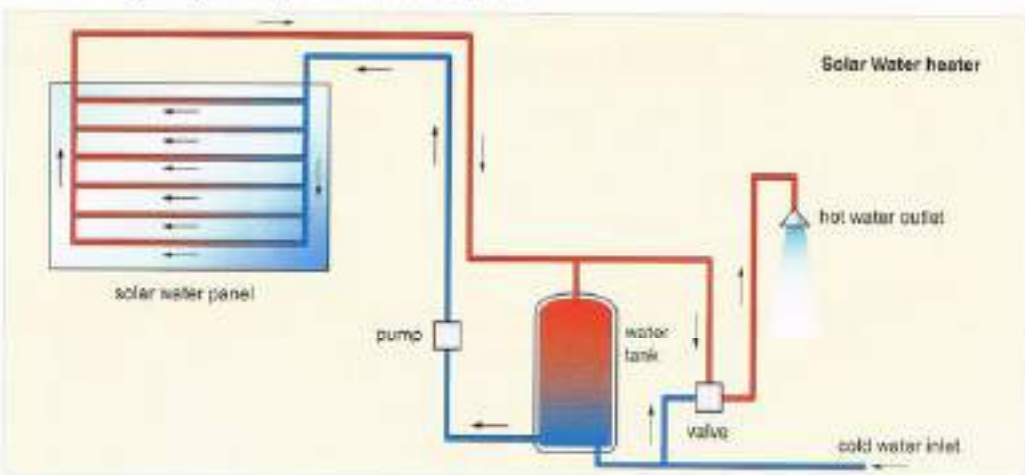

9 Write an explanation of your system.

2 Electrical circuit

- Start here** 1 Do you know these electrical symbols? Label the circuit diagram with the words in the box.

battery conductor fuse lamp
negative positive switch terminal

See the glossary of electrical symbols on page 109 for answers.

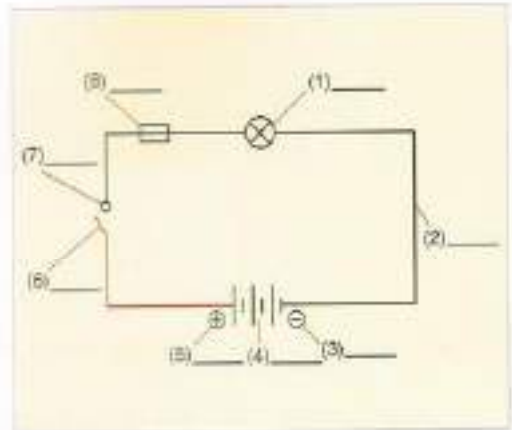

- Listening** 2  28 Listen and label the diagram with the words in the box.

battery cables controller lamps solar panel

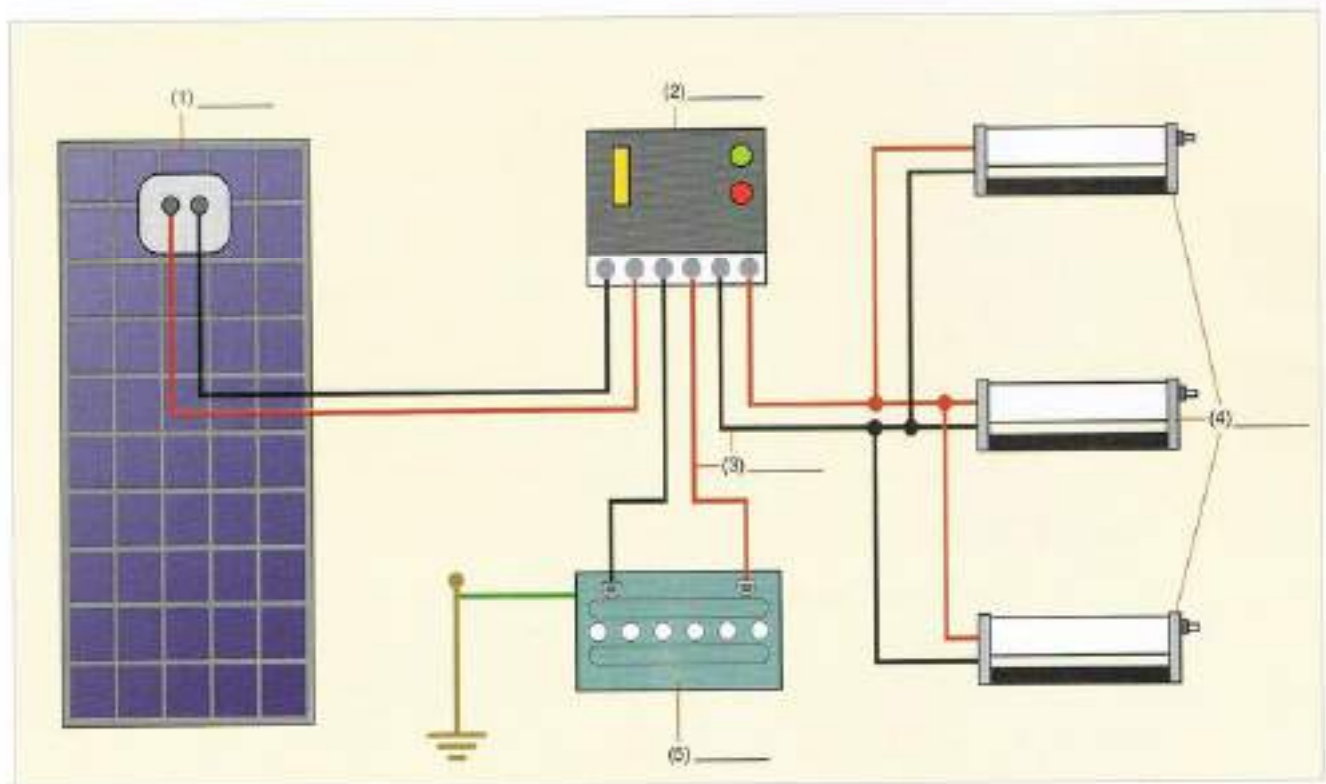

- 3  29 Listen and match the items with their specifications.

- | | |
|----------------------|--------------|
| 1 solar panel | a) 12V 8W |
| 2 controller | b) DC |
| 3 battery | c) 5A |
| 4 lamps | d) 60W |
| 5 electrical current | e) 12V 100Ah |

- Task** 4 Work in pairs. Look again at the diagram in 2. Where does the current flow in these three situations? Draw arrows.

Situation 1: The Sun shines. The lamps are on.

Situation 2: The Sun shines. The lamps are off.

Situation 3: The Sun doesn't shine. The lamps are on.

5 Read the manual for the solar panel and check your answers to 4.

How does the solar power system work? The panel converts the Sun's energy into a DC electric current. The current flows to the controller. Then it can flow from the controller to the lamps. Or it can flow from the controller into the battery. The battery stores the electricity. The current can flow from the battery into the lamps through the controller.

If the Sun shines, the DC current can flow from the panel, through the controller and into the lamps. If the Sun doesn't shine, the current can flow from the battery, through the controller and into the lamps. If the lamps are off, the current can flow from the panel, through the controller, and into the battery.

The controller controls the flow of the current. If the battery is full, the controller stops the flow from the panel into the battery. If the battery is empty, the controller stops the flow from the battery into the lamps.

Language

if	the Sun	shine	-s	,	the current flows from the panel.
	the Sun	does not/doesn't	shine	,	the current flows from the battery.
if	the battery	is	full	,	the current doesn't flow into the battery.
	the lamps	are not/aren't	on	,	the current flows into the battery.

- Task 6** Work in pairs. How do you think the controller below works? Make notes.
- 7** Complete the text explaining how the controller works. Choose the correct verb and use the correct form of the verb.

If the battery is full, switch A (1) _____ (open/close). Then the current (2) _____ (flow/not flow) from the panel to the battery. The controller short-circuits the panel.

If the battery is empty, switch B (3) _____ (open/close). Then the current (4) _____ (flow/not flow) from the battery to the lamp.

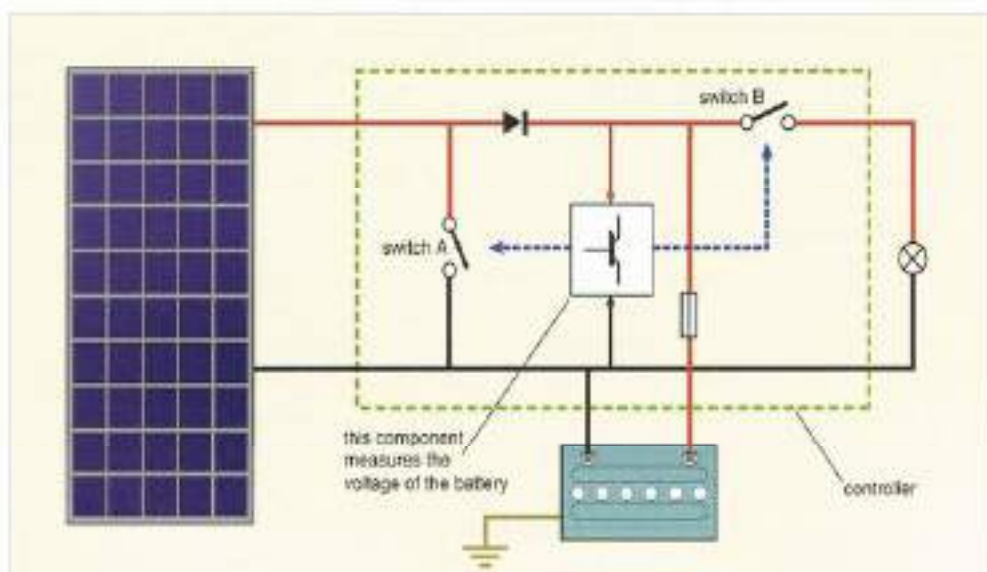

3 Cooling system

Start here 1 Try this quiz. Choose the correct answer.

What are the normal or average temperatures for these?

- | | | |
|---------------------------------|-------------------|-----------------|
| 1 Water from a shower? | a) 60°C (140°F) | b) 80°C (176°F) |
| 2 Food in a refrigerator? | a) 4.5°F (-15°C) | b) 40°F (4.5°C) |
| 3 Food in a freezer? | a) 0°C (32°F) | b) -18°C (0°F) |
| 4 Coldest air temperature ever? | a) -89°C (-128°F) | b) -20°C (-4°F) |
| 5 Hottest air temperature ever? | a) 156°F (70°C) | b) 136°F (58°C) |
| 6 Water in running car engine? | a) 110°C (230°F) | b) 45°C (110°F) |

$^{\circ}\text{F} = ^{\circ}\text{C} \times 9/5 + 32$.
This converts Celsius to Fahrenheit.
 $^{\circ}\text{C} = (^{\circ}\text{F} - 32) \times 5/9$. This converts Fahrenheit to Celsius.

Listening 2 30 Listen and check your answers.

Reading 3 Label the diagram with the words in the box.

bottom hose engine radiator thermostat top hose water pump

Car cooling system

The engine drives the water pump and the pump pushes cool water around the engine. This cools the engine. At the same time, the water becomes hot. The water in a hot engine is normally around 110°C.

5 The hot water then passes through the thermostat. This controls the temperature of the engine. From the thermostat, it flows through the top hose into the radiator. Here, a fan cools the water, and the cool water sinks to the bottom of the radiator.

10 The cool water then leaves the radiator. It flows along the bottom hose, passes through the pump and enters the engine again.

4 Read the text. Check your answers to 3.

5 Which words in the text do these words refer to?

- | | | | |
|-----------------|--------------|---------------|----------------|
| 1 This (line 6) | a) hot water | b) thermostat | c) temperature |
| 2 it (line 7) | a) engine | b) thermostat | c) water |
| 3 Here (line 8) | a) top hose | b) radiator | c) fan |
| 4 It (line 10) | a) water | b) radiator | c) bottom hose |

Speaking 6 Make true sentences.

(1) The water pump	control(s)	the radiator to the engine.
(2) The thermostat	connect(s)	air onto the radiator.
(3) The two hoses	push(es)	the hot water from the engine.
(4) The radiator	cool(s)	water around the engine.
(5) The fan blades	flow(s)	to the bottom of the radiator.
(6) Cool water	rise(s)	the temperature of the water.
(7) Hot water	sink(s)	through the two hoses.
(8) Water	blow(s)	to the top of the engine.

- Task 7** Work in groups. This is a simple way to cool a house in a hot country. How does it work? What happens at each stage (1-11)?

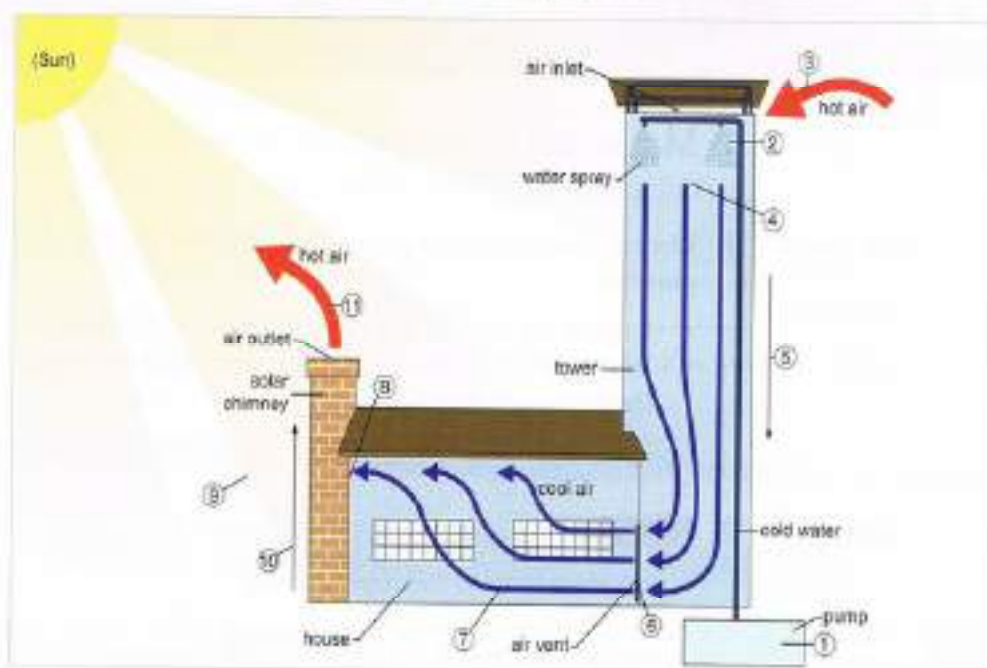

- Writing 8** Complete this description of how the cooling system works with the verbs and prepositions in the box.

cool enter flow heat leave rise sink
around into out of through to

The pump pushes cold water through the pipe to the top of the tower (1). Here, the water leaves the pipe through small holes. It's like a cold shower. (2). Hot air _____ the tower _____ the air inlet (3). The shower of cold water _____ the air (4). The cool air then _____ to the bottom of the tower (5). The cool air _____ the house, (6) and then it _____ (7). It _____ the house and _____ the solar chimney (8). The Sun _____ the chimney, (9) and the hot air _____ (10). The hot air finally _____ the chimney _____ the air outlet (11).

- Social English 9** 31 Listen and read.

Dan is an electronics student. He also works part-time in an electronics workshop.

- *I work in the electronics workshop every Thursday and Friday.*
- When do you attend lectures?
- *Every Tuesday morning.*
- What do you do on Tuesday afternoons?
- *I do my practical work then.*

- 10** Work in pairs. Practise the dialogue.
11 Work in pairs. Discuss your own weekly schedule.

*on Mondays = every Monday
on Monday mornings = every
Monday morning*

1 Materials testing

Start here 1 Work in pairs. Read the instructions and answer the question.

- Look at the helmet and rope. What are they made of?
- Design tests for them. Use diagrams and the words in the box.

break nylon polycarbonate pull stretch strike

Listening 2  32 Listen and answer the questions.

1 What material is the rope made of?

2 What is the lecturer doing?

3 Is the rope breaking?

3 Listen again and complete the dialogue.

- I'm (1) _____ the rope. I'm (2) _____ it.
Is it (3) _____?
- No, it (4) _____.
- That's right. It (5) _____.



Language This is the *present continuous* form of the verb. Use it to describe what is happening at the same time as you are speaking.

	I	'm am	pull	-ing	the rope.
	The rope	isn't is not	break	-ing.	
What	are	you	do	-ing?	
	is	the rope	break		

Vocabulary 4 Match the actions with the verbs in the box.

bend compress cut drop heat scratch stretch strike



Language 5 The lecturer is testing other materials. Complete his description.

- Now I (1) *in heating* (heat) this plastic to 100°C. Can you see?
It (2) _____ (not melt).
OK, now I (3) _____ (put) this helmet on the floor. And
now the machine (4) _____ (drop) a 10 kg weight on it.
Right, now look at Dr Wilson. He (5) _____ (strike) the
metal plate with a hammer. But the plate (6) _____
(not bend).
OK, now the jaws of the vice (7) _____ (compress)
this plastic block. The block (8) _____ (not break).
Now Dr Wilson (9) _____ (hang) a weight of 500 kg
from the ropes. But the ropes (10) _____ (not stretch).

Note the spelling changes:
strike → striking
drop → dropping
cut → cutting

Speaking 6 What are the people in the gym doing? Describe this picture using the words in the box.

bend cycle hold lift pick up pull push run sit stretch touch



7 Ask and answer questions about the picture in 6.

- A: What's D doing? Is he pushing the bar up?
B: No, he isn't. He's pulling the bar down.

8 Work in pairs. Guess the sport from the mime.

Student A: do the actions.

Student B: guess what Student A is doing. Then change roles.

A: Watch me. (Mime a sport). What am I doing now?

B: Are you diving?

A: No, I'm not diving.

B: I know. You're swimming.

A: Yes, you're right. I'm swimming.

2 Properties

- Start here** 1 Work in pairs. What are the most important properties of the materials in the box? Discuss with your partner.

ceramic concrete diamond fibreglass graphite steel

Example: You can't burn/melt/break/scratch/bend/cut it (easily).

- Vocabulary** 2 What are these made of? Match the photos with these materials.

aluminium ceramic fibreglass graphite nylon
polycarbonate polystyrene rubber steel titanium



- Speaking** 3 Underline the stressed syllable.

- 1 ny lon 5 al u min i um
2 graph ite 6 pol y sty rene
3 ce ram ic 7 ti ta ni um
4 pol y car bon ate 8 fi bre glass

fibreglass (BrE) = fiberglass
(AmE)
aluminium (BrE) = aluminum
(AmE)

- 4 33 Listen and check your answers to 3. Say the words with the correct stress.

Language

What	is 's	this helmet	made of?	It	is 's	made of	polycarbonate, nylon.
What	are 're	those ropes	made of?	They	are 're	made of	polycarbonate, nylon.

- 5 34 Listen and repeat.

- *What's this made of?*
- *It's made of ceramic.*
- *What are these made of?*
- *They're made of polycarbonate.*

- 6 Work in pairs. Make similar questions and answers about the photos in 2.

Vocabulary 7 Match the sentences.

- | | |
|--|------------------------------|
| 1 This material doesn't burn or melt if you heat it. | a) It's rigid. |
| 2 This material doesn't break if you strike it or drop it. | b) It's hard. |
| 3 You can't bend this material. | c) It's tough. |
| 4 This material doesn't corrode if you put it in water. | d) It's heat-resistant. |
| 5 You can't scratch this material or cut it. | e) It's corrosion-resistant. |

8 Match the words with their opposites.

- | | |
|----------|-------------|
| 1 tough | a) soft |
| 2 hard | b) heavy |
| 3 rigid | c) weak |
| 4 strong | d) brittle |
| 5 light | e) flexible |

Reading 9 Read the text and complete the table below.

This racing car is made from the latest hi-tech engineering materials. It's made from metals, alloys, ceramics, plastics and composites. Many materials in the car are light, but very strong.

The nose cone of the vehicle is made of strong, light fibreglass.

The spoiler and the wings are made from two materials. The inner core is light. It's made of polystyrene. The outer skin is hard and made of fibreglass.

The frame is light, but very tough and rigid. It's made of cromoly, a steel alloy.

The radiator is made of aluminium. The aluminium is coated with ceramic. These two materials are corrosion-resistant.

The engine and pistons are made of a light aluminium alloy. Each piston inside the engine is coated with a heat-resistant ceramic.

The wheels are made of a strong, light aluminium alloy. The tyres are made of a tough rubber composite.



an alloy is a mixture of two or more metals
a composite is a mixture of two types of material
fibreglass is a composite. It is a mixture of a plastic and a ceramic

BrE tyre, AmE tire

Part	What's it made of?	What are its properties?
nose cone	(1)	(2)
spoiler and wings	coated with (3)	(4)
wheels	(5) alloy	(6)
tyres	(7) composite	(8)
pistons	coated with (9)	(10)
frame	(11)	(12)
radiator	(13)	(14)

3 Buying

Listening 1  **35** Listen and complete the customer call form.

Customer Call Information	
Name:	Manuel
Phone number:	
Email address:	
Message:	

2  **36** Listen and write the correct email and web addresses.

When you hear this	write this
1 waleed at sports dot com	waleed@sports.com
2 adam at city dot co dot U, K	
3 theo walcott, that's T-H-E-O then W-A-L-C-O-T-T at goalfeast, that's G-O-A-L-F-E-A-S-T all one word dot com	
4 C dot ronaldo, that's R-O-N-A-L-D-O at back-of-the-net, that's B-A-C-K dash O-F dash T-H-E dot net	
5 www dot toyota, that's T-O-Y-O-T-A dot com forward slash customer dash support	
6 www dot orascom, that's O-R-A-S-C-O-M dot com dot E-G forward slash sales underscore one	

Speaking 3 Work in pairs. Dictate the addresses to your partner.
Student A. Turn to page 114. Student B. Turn to page 118.

Listening 4  **37** Listen to this phone conversation and complete the questions.

Never put a stress on the -y in numbers like thirty, forty, fifty and so on.
Tip: say seventy but seventeen to make the difference clear.

- What's your surname, please?
- It's Lint.
- Could you (1) _____ that, please?
- Lint.
- Could you (2) _____ that, please?
- L-I-N-T.
- (3) _____ T or D?
- It's T. T for teacher.
- Thanks. And what's the product number?
- It's 17-305.
- (4) _____ 17 or 70?
- Teen. Seventeen. One seven.
- Right. Thanks.

Speaking 5 Practise the phone call in pairs. Then change roles.

Task 6 Work in pairs. Buy sports equipment over the telephone.

Student A. Turn to page 116.

Student B:

- 1 You are the customer. Circle three items you would like to buy, and circle the features you want (size, colour, material), and the price. Then phone up the shop and place your order. You can either make up details (e.g. names, phone numbers, etc.) or use your own.
- 2 Then change roles. You are now the sales person in the sports shop. Ask Student A questions and complete this order form.

no. = number
= number

helmet: polycarbonate (product # 16-384: \$80/£40/€60) or fibreglass (product # 18-399: \$70/£35/€50). Sizes: L, M or S.
Other colours:

jacket: cotton (product # 14-556: \$70/£37/€58) or polyester (product # 17-765: \$75/£40/€60). Sizes: XL, L, M, S.
Other colours:

rope: nylon (product # 13-246: \$40/£18/€25 per 25 m) or nylon + rubber composite (product # 30-356: \$45/£22/€33 per 25 m). Sizes: 50 m/75 m/100 m.
Other colours:

backpack: nylon (product # 19-231: \$120/£60/€90) or polyester (product # 90-113: \$110/£55/€85). Sizes: XL, L, M, S.
Other colours:

USEFUL LANGUAGE

- What's your name/phone number/email address?
- Could you spell/repeat that, please?
- Is that sixteen or sixty?
- What's the product name/number?
- What colour/size/material would you like/do you need?
- Do you want to pay in dollars (\$), sterling (£) or euros (€)?
- How many would you like/do you need?

Name						
Phone no.						
Email address						
Order						
Product name	Product no.	Colour	Size	Material	Price	Quantity

Social English 7 38 Listen to three telephone calls. Mike (M) is phoning his friend John (J).

<p>1</p> <p>J Hello?</p> <p>M Hello. Is that John?</p> <p>J Yes?</p> <p>M It's Mike.</p> <p>J Oh hi, Mike.</p> <p>M Hi. How are you?</p> <p>J OK, thanks. How are you?</p> <p>M Fine. (Begin your call).</p>	<p>2</p> <p>Hello?</p> <p>Hello. Is that John?</p> <p>Yes. Is that Mike?</p> <p>Yes, it's me. Hi. How are you?</p> <p>Fine, thanks. How about you?</p> <p>I'm fine. (Begin your call).</p>	<p>3</p> <p>Hello. John Davis here.</p> <p>Oh hi, John. This is Mike.</p> <p>Hi, Mike.</p> <p>Hi. How are things?</p> <p>Great, thanks. How are you?</p> <p>Good. (Begin your call).</p>
---	---	---

8 Work in pairs. Practise short phone calls, using your own names.

Review Unit C

1 Look at the pictures and give instructions with the words in the box.

bend close cut drive in grip loosen measure open
pull out put put on strike take take off tighten use

Examples: 1 Grip the nail. Use a pair of pliers. 2 Pull out the nail.



2 Say what is happening in the pictures in 1.

Example: 1 He's gripping the nail. He's using a pair of pliers.

3 Correct the mistakes in these sentences.

1 Water boils at 32°F. (freeze)

Water doesn't boil at 32°F. It freezes.

2 Hot water sinks to the bottom of a tank. (rise / top)

3 Cool air rises to the top of a room. (sink)

4 Hot air sinks to the bottom of a room. (stay / top)

5 The Sun's rays cool the water in the solar panel. (heat)

4 Complete the dialogue with the correct form of the verbs in brackets.

- How does the thermosiphon (1) _____ (work)?
- Well, the cold water (2) _____ (enter) the system through the inlet. The water pressure (3) _____ (push) the water around the system.
- So how (4) _____ (do) the water (5) _____ (become) hot?
- It (6) _____ (flow) into the panel and the sun's rays (7) _____ (heat) it. The warm water (8) _____ (rise) to the top of the panel and it (9) _____ (pass) from the panel into the tank.
- (10) _____ (do) the tank (11) _____ (have) a heater?
- No, it (12) _____ (do not). The hot water (13) _____ (stay) at the top of the tank. If you (14) _____ (open) the valve, the hot water (15) _____ (flow) from the top of the tank to the outlet.

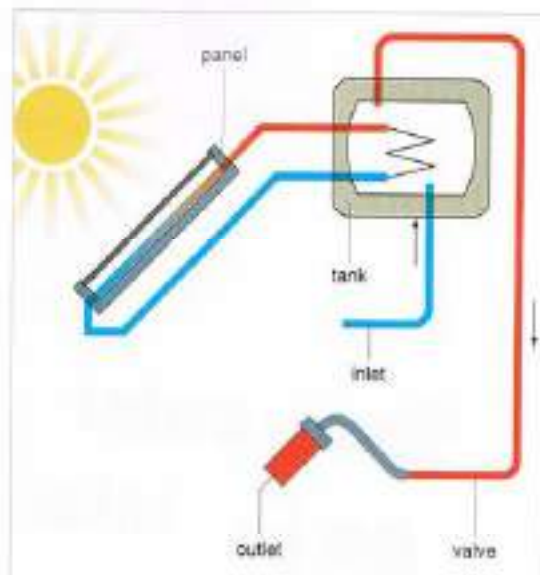

5 Identify the equipment from the description.

cable fan pump radiator solar panel thermostat

- 1 It converts energy from the Sun into heat or electricity.
- 2 It pushes water around a water supply system, or around a car engine.
- 3 It blows cold air onto a car radiator and cools the water inside it.
- 4 It controls the temperature of water or air in a heating or cooling system.

6 There's a problem with the forklift truck. Say what's going wrong.

- 1 I impressing (press) the accelerator pedal, but the truck isn't going (not go) faster.
- 2 He _____ (pull) the lever back, but the forks _____ (not rise).
- 3 You _____ (push down) the brake pedal, but the truck _____ (not slow).
- 4 I _____ (slide) the lever forwards, but the forks _____ (not tilt) upwards.
- 5 He _____ (pull) the direction lever backwards, but the truck _____ (not reverse).
- 6 You _____ (move) the direction lever forwards, but the truck _____ (not go) forwards.

7 Complete the sentences with *bend* or *break* and other words.

- 1 Polyester is a tough material. You can't _____ it easily.
- 2 Concrete is a rigid material. It doesn't _____ easily.
- 3 Polycarbonate is a hard material. It _____.
- 4 This glass is brittle. You _____.
- 5 These plastic rulers are very flexible. They _____.

8 Draw a line from each word to its opposite.

rise enter into heavy strong
go in inlet push light pull
sink open out of tough hard
go out to outlet soft flexible
close leave weak brittle
go down from rigid go up

9 Complete the sentences with the correct form of the verb in the box.

boil freeze melt rise sink stretch

- 1 If you heat water to 100°C, it _____.
- 2 If you cool water to 0°C, it _____.
- 3 If a heater warms the air in a room, the air _____.
- 4 If an air conditioner cools the air in a room, the air _____.
- 5 If you heat steel bars to 1400°C, they _____.
- 6 If you pull a copper wire very hard, it _____.

10 Identify the material from the description. Choose from the words in the box.

aluminium ceramic polycarbonate polystyrene rubber steel

- 1 Sunglasses are made of this material. It's a hard and tough plastic.
- 2 You can stretch this material and you can bend it, but it doesn't break.
- 3 You can heat this material to a high temperature, but it doesn't burn or melt. They use it in spark plugs.
- 4 Parts of aeroplanes are made of this material. It's a strong, light, corrosion-resistant metal.

11 Make dialogues about the parts of a racing car.

- 1 nose cone / fibreglass / strong and light
- 2 pistons / aluminium alloy / light and corrosion-resistant
- 3 frame / cromoly / tough and rigid
- 4 tyres / rubber composite / tough
- 5 radiator / aluminium and ceramic / corrosion-resistant
- 6 outer skin of spoiler / fibreglass / hard

A: *What's/What are the ... made of?*

B: *It's/They're made of ...*

A: *Why do they/we/you use ... ?*

B: *Because it's ...*

12 Complete the text with the correct form of the verbs in brackets.

This is how you test the properties of the material. You put the material into the multi-test machine. Then the machine does four tests on it. In the first test, a hammer (1) _____ (strike) the material with a 50 kg weight. In the second test, two pairs of jaws (2) _____ (pull) the material with a weight of 80 kg. In the third test, a heavy weight of 100 kg (3) _____ (press) the material down. In the fourth test, two sharp knives (4) _____ (scratch) the material with weights of 10 and 20 kg.

OK, now I'm demonstrating the four tests in action. Watch carefully. Here's the first test. The hammer (5) _____ (strike) the bar. Can you see? The bar isn't breaking. Here's the second test. It's starting now. The jaws (6) _____ (pull) the material. Can you see? The material (7) _____ (not stretch). Now the third test is taking place. The heavy weight (8) _____ (press) the material down. Can you see that? The material (9) _____ (not break). And now here's the fourth and final test. The knives (10) _____ (scratch) the material.

Projects 13 Find out what these word parts mean. Then find other words with the same word part.

Word part	Meaning of word part	Example of word	Meaning of word
sol-		1 solar	1
		2	2
poly-		1 polytechnic	1
		2	2

14 Find out about materials you use in your industry. Make your own table and complete it.

Example:

Industry: <i>Aerospace</i>		
Application	Material	Property
<i>Wing parts</i>	<i>Aluminium alloys</i>	<i>Light, strong, corrosion-resistant</i>

1 Dimensions



Start here 1 What do you know about this bridge?

- 1 What's it called?
- 2 Where is it?
- 3 How high is it?

Listening 2  39 Listen to part of a TV programme about the bridge. Check your answers to 1.

3 Work in pairs. Which of the following can you see in the photo?

cable deck pier pylon span

4  40 Listen to the next part of the TV programme and complete the specifications of the bridge.

BrE: metre, millimetre,
centimetre.
AmE: meter, millimeter,
centimeter.

Don't add -s to abbreviations
of units.
say: one hundred metres /
kilometres; write: 100 m / 100 km

Millau Bridge: specifications			
Structure	(1) <i>cable-stayed</i>	Length of outer spans	(7) m
Completion date	(2) <i>December 2004</i>	Number of piers	(8)
Material: cables and deck	(3)	Height of pylons above deck	(9) m
Material: piers	(4)	Height of deck above water	(10) m
Total number of spans	(5)	Length of deck	(11) km
Length of inner spans	(6)	m	Width of deck (12) m

Vocabulary 5 Complete the table.

Adjective	high	long	_____	wide
Noun	_____	_____	depth	_____

6 Complete the sentences with the correct word in brackets.

- The _____ of the road is 6 m. (wide/width)
- The river is 230 km _____. (long/length)
- The sea has a _____ of 330 m. (deep/depth)
- These pylons are over 80 m _____. (high/height)
- These oil wells are more than 700 m _____. (deep/depth)
- The total _____ of the road is about 120 km. (long/length)
- The tunnel is 15 m _____. (wide/width)
- The _____ of the bridge is 130 m. (high/height)

Language

How	high	is it? are they?	It's They're	2	millimetres	high.
	wide			10	centimetres	wide.
	long			100	metres	long.
	deep			1000	kilometres	deep.

Speaking 7 Make questions about the Millau Bridge. Use the specification chart in 4.

8 Work in pairs. Ask and answer your questions in 7.

Example:

TV presenter: How long are the inner spans?

Engineer: They're 342 metres long.

Task 9 Work in pairs. Find out the specifications of your partner's bridge.

Student B. Turn to page 118.

Student A:

- Ask Student B questions about the Akashi-Kaikyo Bridge. Complete your specifications chart.
- Then change roles. Turn to page 114 and answer Student B's questions about the Rion-Antirion Bridge.

Akashi-Kaikyo Bridge: specifications	
Type of structure	<i>Suspension</i>
Country	
Piers (number)	
Span (length)	
Deck (above water)	
Deck (length)	
Water (max depth)	
Water at main pier (depth)	



The Akashi-Kaikyo Bridge

2 Quantities

- Start here** 1 Try the quiz. Match the names of the buildings to the pictures. Write the number and the approximate height of each building.

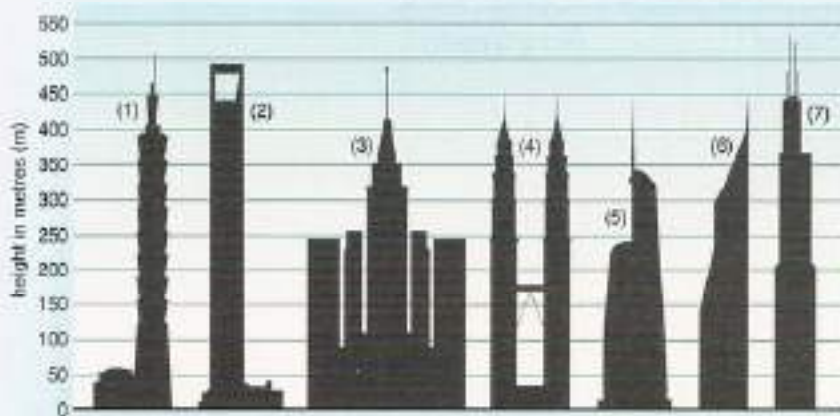

- A Dubai Towers Doha, Qatar**
(Picture # ____; height ____ m)
- B Federation Tower, Russia**
(Picture # ____; height ____ m)
- C Abraj Al Bait Towers, Saudi Arabia**
(Picture # ____; height ____ m)
- D Sears Tower, USA**
(Picture # ____; height ____ m)
- E Petronas Towers, Malaysia**
(Picture # ____; height ____ m)
- F Taipei 101, Taiwan**
(Picture # ____; height ____ m)
- G Shanghai World Financial Centre, China**
(Picture # ____; height ____ m)

- 2 41 Listen and check your answers to 1.

- Reading** 3 Read the FAQs from the website and match them to the answers.

BrE (t) = AmE elevator

write: 8000 m²; say: eight thousand square metres.
write: 250,000 m³; say: two hundred and fifty thousand cubic metres.
write: 5 kg; say: five kilograms or five tons.

This is Taipei 101. It is currently the highest in the world. Here are some frequently asked questions (FAQs) about the building.

- 1 How high is Taipei 101?
- 2 What's the footprint of the building?
- 3 How many storeys does it have?
- 4 How do you get to the top?
- 5 What's the building made of?
- 6 How much steel and concrete is in the building exactly?

- A About 700,000 tonnes.
- B By super-fast elevator. The building has two high-speed elevators. Each elevator travels at 17 m/s.
- C 101.
- D It towers above Taipei at the amazing height of over 508 metres.
- E Reinforced concrete, steel, aluminium and glass.
- F The base of the building has an area of about 450 m².

Language *Countable nouns* can be both singular and plural. Examples: *screw, nail, bottle*. *Uncountable nouns* are always singular. Examples: *concrete, cement, sand, oil*.

screws are countable		cement is uncountable	
a one	screw	some	cement
some two	screw -s		
a bag of two bags of		a bag of two bags of	

Do you need	some/any	screws? cement?	How	many much	(screws) (cement)	do you need?
-------------	----------	--------------------	-----	--------------	----------------------	--------------

4 Complete the dialogue with the words in the box.

any how many much some What colour What size



- *Good morning. Can I help you?*
- Hello. Do you have (1) _____ screws?
- *Certainly. (2) _____ do you need?*
- Ten mil.
- *OK. And (3) _____ do you need?*
- Fifty, please.
- *Right. So that's fifty 10 mil screws. Anything else?*
- Yes. I need to buy (4) _____ paint, please.
- (5) _____?
- Black.
- *OK. So (6) _____ black paint do you need?*
- Six large tins, please.
- *Anything else?*
- No, that's all, thanks.

5 Make similar dialogues with your partner. Use the questions in the box and the information from the table.

How many? How much?
What colour? What kind?
What size? What type?

write: 15 L; say: 15 litres

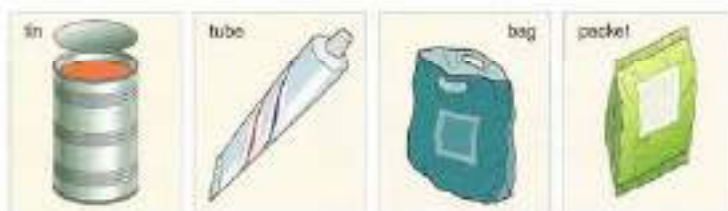

To buy ...		
Item	Quantity	Kind, size or colour
screws	50	10 mm
paint	6 large tins	black
glue	2 tubes	superglue
nuts	30	15 mm
oil	15 L	motor oil
bolts	60	25 mm
cement	20 bags	white
nails	2 packets of 50	20 mm

3 Future projects

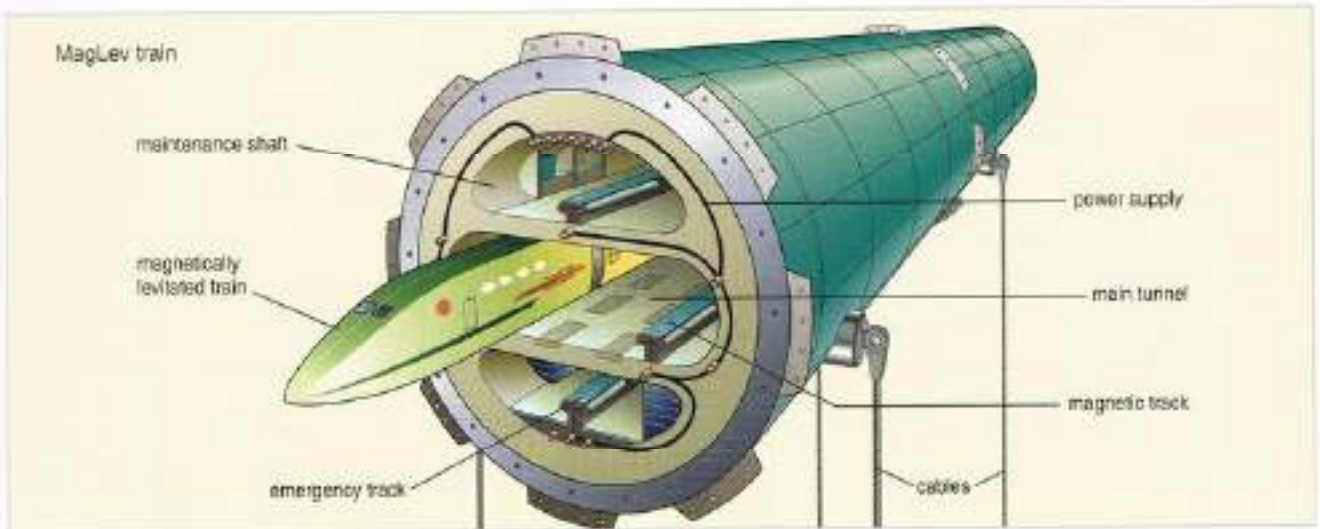

- Start here**
- 1 Work in pairs. Look at the picture. What is it? How does the vehicle move?
 - 2 42 Listen to this radio interview and complete the specification chart.

Trans-Atlantic MagLev Tube	
Location of tube	(1) Under the Atlantic Ocean from Britain to the USA
Possible date of completion	(2) 2100
Length	(3) km
Depth below sea level	(4) m
Number of cables	(5)
Speed of train	(6) km/h
Source of power for train	(7)

Language Use *will* and *won't* to predict a future fact or event.

They/We My company The engineers	will won't	build it in 2050.		
When	will	they/you	build it?	In 2050.
	Will		build it in 2050?	Yes, they will. / No, they won't.

3 Disagree with each statement.

- 1 The engineers will start the tube in 2020. (2080)
- 2 The tube will be under the Pacific Ocean. (Atlantic)
- 3 The tube will connect Britain with Europe. (the USA)
- 4 The train will use diesel. (magnetism)
- 5 The tube will contain compressed air. (a vacuum)
- 6 The trains will travel at 11,000 km/h. (8000 km/h)

Example: 1 They won't start the tube in 2020. They'll start it in 2080.

- Reading 4** Read this interview and produce a specifications chart for the bridge (see 2 on page 56). Use the words in the box.

completion date deck height length materials pier pylon span

Bridge of the Future: Europe-Africa Bridge

RadioTech presenter Tom Burns interviews engineer Galal Hamdy.

- Tom: What project are you working on now?
Galal: We're designing the world's longest bridge.
Tom: Where will it be?
Galal: Between Morocco and Spain. It'll connect Europe with Africa.
Tom: What are the specifications of the bridge?
Galal: It will be almost 15 km long. In our design, the bridge will have two spans. Each span will be 4800 m long.
Tom: That's a very long span. How will that be possible?
Galal: The bridge will have three steel pylons, on concrete piers. The pylons will be 1000 m high. The deck will be very light and strong. It'll be made of fibreglass.
Tom: Many engineers think you won't be able to build this bridge.
Galal: I don't agree. I think we'll complete it around 2030.



- Speaking 5** Work in pairs. Ask and answer questions about the specifications of the bridge.

A: How long will the bridge be? B: It will be almost 15 km long.

- 6** Here is a possible project schedule for the Europe-Africa Bridge. Roleplay an interview between a TV presenter and an engineer.

Task	2024	2025	2026	2027	2028	2029	2030	2031	2032
1 lay foundations		■	■						
2 build piers			■	■	■				
3 put pylons on piers					■	■			
4 attach cables to pylons						■	■		
5 make deck			■	■	■	■	■		
6 fix deck to cables							■	■	■
7 build roads								■	■
8 open bridge									■

TV Presenter: When will you build the piers?

Engineer: We'll start in 2026 and finish in 2027.

- Social English 7** How do you think the world will change in the next 20 years. Think about technology, social, political and legal changes.

Example: Computers will control more things in our homes.

1 Recent incidents

Start here

- 1 Work in pairs. Look at the photo and say what's happening. List five common problems you can have with a car.
- 2  43 Listen to this phone call and complete the details in the form.



Crash Recovery Co Ltd Online customer call information. Enter details

Customer name	(1)
Car Registration No	(2)
Location: Road	(3)
Between Junction (4)	and Junction (5) Going (6)
Problem:	(7) <i>The exhaust pipe</i>

Listening

- 3  44 Listen to the phone calls and match them with the pictures.
- 4 Complete the sentences with the verbs in the box. Put two words in each gap.



broken cut driven fallen had happened have/has lost taken

- 1 Is that Security? Thieves have broken into my office. They _____ my computer.
- 2 Is that the IT hotline? Something _____ to my computer. I _____ all my data.
- 3 I need an ambulance, quickly. My daughter _____ downstairs. She _____ her leg.
- 4 Is that Crash Recovery? I _____ an accident. I _____ my car into a bridge.

Language

You form the *present perfect* with *have/has* + past participle.

- You can use the present perfect to talk about *recent* actions: *My car has broken down. I've changed the tyre.*
- The present perfect does not go with dates, times or time expressions such as *yesterday, a week ago, in 2005*. Use the past simple with these expressions.

- 5 Check you know the past participle of these verbs. Which ones are *irregular*?

buy check crash fall order put repair
sell send speak steal take write

Speaking 6 Work in pairs. Make short dialogues.



A is the supervisor in a car repair workshop. B is a mechanic in the workshop.

- 1 check the brakes ✓ repair the tyres ✗
- 2 order those new parts ✓ buy those tools ✗
- 3 change the tyres ✓ clean the spark plugs ✗
- 4 phone the customer ✗ speak to our supplier ✓
- 5 write that report ✓ send that email ✗
- 6 put in the new fuses ✗ take out the old lamps ✓

A: Have you checked the brakes?

B: Yes, I have.

A: Good. What about the tyres? Have you repaired them?

B: No, I haven't. I'll do it now.

7 Try this memory test.

- Look at the picture on page 117 for one minute.
- Then look at the picture below. How many differences are there? Compare with a partner.

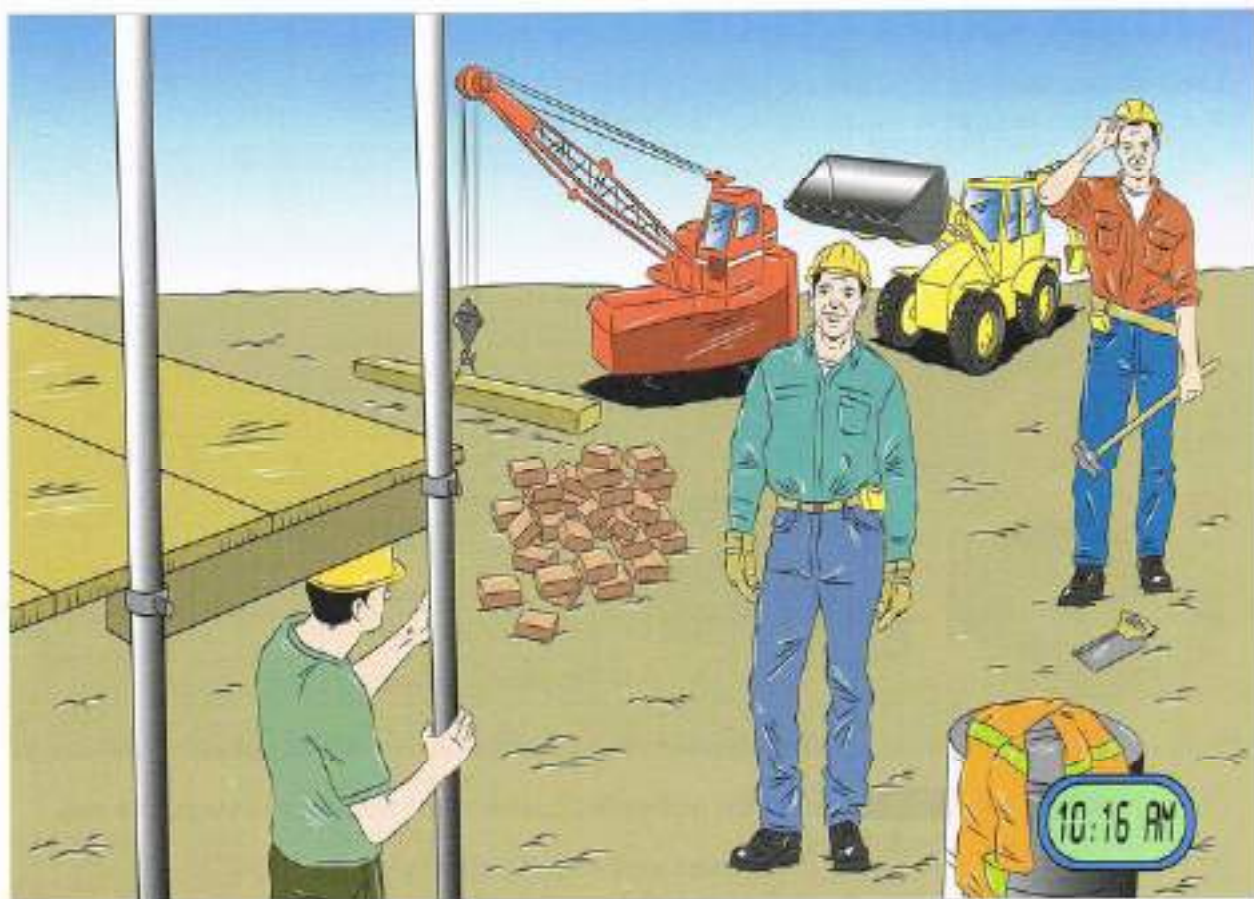

8 It is now 10.16 am. Explain what has happened in the picture since 10:12 am. Use the words and verbs in the box.

beam bricks bucket builder crane digger
hard hat jacket scaffolding sledgehammer

climb down drive fall over lower move back pick up put put on raise take off

Example: 1 Two builders have taken off their jackets.

2 Damage and loss

Start here 1 Do you have any damaged tools or equipment? Describe the damage to your partner.

Vocabulary 2 Do you remember the verbs in the box? Match them with the pictures.

bend break burn crack cut dent scratch tear



Task 3 Correct the mistakes in this checklist.

Quick Start guide

Check all these items are in the box and in good condition.

If any items are damaged or missing contact Customer Services immediately.

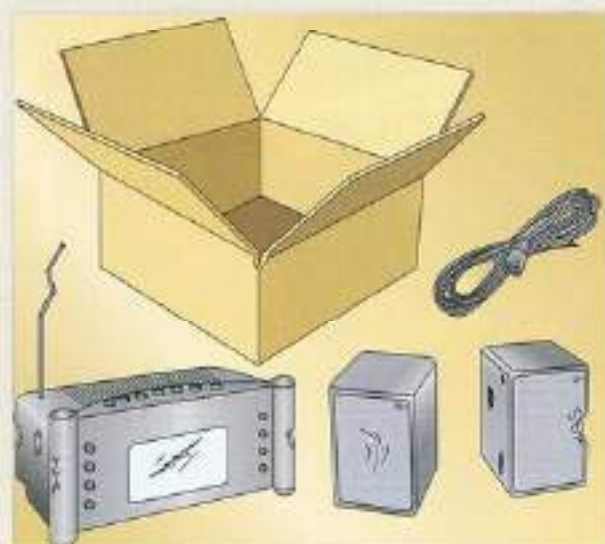

item	in box	condition
radio	✓	<i>damaged</i>
• radio antenna		<i>OK</i>
• body of radio		<i>cracked</i>
• display screen		<i>OK</i>
power cable with plug	<i>no plug</i>	<i>cable OK</i>
4 AA batteries	✓	<i>OK</i>
1 user manual	<i>no manual</i>	-
1 pair headphones	✓	<i>OK</i>
1 LH external speaker	✓	<i>OK</i>
1 RH external speaker	✓	<i>OK</i>
2 cables for speakers	✓	<i>OK</i>

Listening 4 45 Look at the picture in 3. Listen to the telephone conversation and check the list.

Speaking 5 Look at the picture in 3 again. Make sentences about the damage and the things that are missing. Use these sentence patterns.

Ways to report damage	Ways to report something missing
The screen is scratched.	The manual is missing.
There's a scratch on the screen.	There's no manual in the box.
The speakers are dented.	The cable has no plug. / The cable doesn't have a plug.
There are some dents on the speakers.	There's no plug on the cable.

Language

Focus on action		Focus on result of action			
I have	dented	the radio.	The radio	is	dented.
He has	broken	the speakers.	The speakers	are	broken.
	past participle				adjective

6 Rewrite the sentences in the same way as in the table above.

Focus on action	Focus on result of action
1 I've scratched the display screen.	
2 Someone has bent the antenna.	
3 I've burnt the body of the radio.	
4 Someone has dented the top of the speaker.	
5 They've cracked the cover of the plug.	
6 Someone has torn the user manual.	

7 Complete the sentences with the correct form of the words in the box.

bend crack out dent scratch tear



- The side of the box is _____.
- The lenses of the goggles are _____.
- The surface of the road is _____.
- The insulation of the cable is _____.
- The pipe below the tank is _____.
- The overalls are _____.

8 Rewrite the sentences in 7 to give the same meaning.

There's a ... / There are some ...

Example: 1 There's a dent in the side of the box.

Task 9 Work in pairs. Find out the damage to your partner's car.

Student A:

- Ask Student B questions about the damage to their car. Label your diagram.
- Then change roles. Turn to page 115.

Student B. Turn to page 116.

- What's the problem?
- The door is scratched.
- Which door?
- The back / front nearside one.
- Anything else?

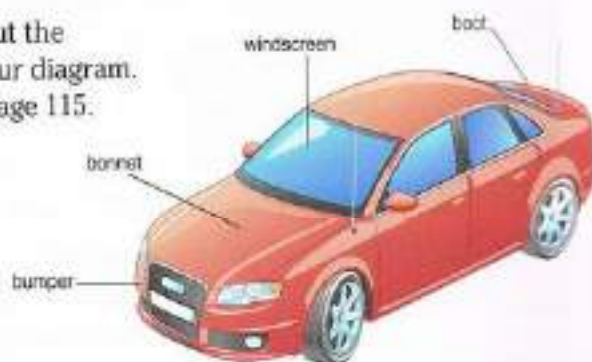

front & rear
The steering wheel is always
offside

3 Past events

Start here 1 Work in pairs. When did these events happen?

Give the approximate year of the first ...

- | | |
|----------------------|---|
| 1 space station | 6 spacewalk |
| 2 telescope in space | 7 man on the Moon |
| 3 man in space | 8 shuttle in space |
| 4 space tourist | 9 crew to enter the International Space Station |
| 5 satellite | 10 European navigation satellite |

Reading 2 Read this chart and check your answers to 1.



Event

Date

- | | |
|---|------------------|
| 1 The Russians launched Sputnik, the first satellite. | 5 October 1957 |
| 2 Yuri Gagarin became the first man in space. | 12 April 1961 |
| 3 Leonov made the first walk in space. | 18 March 1965 |
| 4 The first men, Armstrong and Aldrin, landed on the Moon. | 20 July 1969 |
| 5 The Russians launched the first space station, Salyut 1. | 19 April 1971 |
| 6 The Americans put the first shuttle into space. | 12 April 1981 |
| 7 NASA sent the Hubble telescope into space. | 24 April 1990 |
| 8 The first crew entered the International Space Station. | 2 November 2000 |
| 9 The first space tourist flew into space. | 28 April 2001 |
| 10 The Europeans launched Galileo, a global navigation satellite. | 28 December 2005 |

Language This is the *past simple* form of the verb.

- You can use it to talk about *past events*.
- Use the past simple with dates, times or expressions such as: *yesterday, last year, When?*

When	did	he/she/it/they/we/you	go travel	there?
		He/She/It/They/We/You	went travelled	there in 2007.

Speaking 3 Make questions and answers about the table in 2.

- A: *When did the Russians launch Sputnik?*
 B: *They launched it on the 5th of October 1957.*
 (or: *They launched it in 1957.*)

Use *on* for the exact day:
 on the 14th of May 2005.
 Use *in* for a month or a year:
 in May, in 2005.

Vocabulary

ago = before now

You can say the *15th* of November or *November the 15th*.

If it is the 15th of November today ...

- *two days ago* = 13th November
- *two weeks ago* = 1st November
- *two months ago* = 15th September

If it is 10.15 now ...

- *five minutes ago* = 10.10
- *an hour ago* = 9.15
- *two hours ago* = 8.15

- 4 Write the name of this month on the calendar. Put a circle round today's date. Then say what the following dates are.

- 1 today
- 2 yesterday
- 3 the day before yesterday
- 4 two days ago
- 5 one week ago
- 6 two weeks ago



- 5 Make statements about the chart in 2 using **ago** and approximate years from today's date.

Example: 1 The Russians launched Sputnik more than 50 years ago.

- 6 46 Listen and complete the phone call.

- Hello, Electronic Repairs. Don speaking. How can I help you?
- *Hi. My name's Ben Jones. I've (1) _____ my MP3 player. Can you repair it?*
- OK, sir. What's the model number?
- *It's a Super 30 GB.*
- And when did you (2) _____ it?
- *Er, let's see ... Yes, I (3) _____ it on the 18th of August.*
- And what's the problem?
- *I've (4) _____ it and I've (5) _____ the screen.*
- And, er ... when did you (6) _____ the screen?
- *Yesterday.*
- OK, bring it into the shop and I'll look at it.
- *Thanks. Bye.*

- 7 Work in pairs. Make similar phone calls.

	Item 1	Item 2	Item 3
Item:	MP3 player	mobile phone	laptop
Model no:	60 GB	9300	Travel 380
Date of purchase:	15 th February	13 th October	21 st July
Damage:	dented cover	dropped in water	broken cover
Date of damage:	three days ago	day before yesterday	two weeks ago

- Social English 8 Make a list of interesting things you have done in your life, with their dates.

- *climbed Mont Blanc in June 2006*
- *snorkelled in the Red Sea in August 2007*

- 9 Tell other students in your class about your list.

Review Unit D

1 Make questions for these answers.

1 It's about 50 m wide. (the road)

How wide is the road?

2 They're 90 m high. (the pylons)

3 It's more than 2 km long. (the deck of the bridge)

4 It's about 35 m in height. (the scaffolding)

5 They're 15 m deep. (the foundations of the building)

6 They're about 12 m in length. (the steel beams)

2 Change these nouns to adjectives

1 depth _____ 3 width _____

2 height _____ 4 length _____

3 Rewrite the sentences to give the same meaning.

1 What is the height of the bridge? 4 The length of the new road is 355 km.
How high is the bridge? This new road is _____.

2 The height of the tower is 46 m. 5 What are the widths of the screws?
The tower is _____ How _____?

3 What is the depth of the sea 6 The depth of the well is more
under the bridge? than 30 m.
How _____ The well is _____.
_____?

4 Make questions for these answers.

1 It has ten. (storeys / building)

How many storeys does the building have?

2 He needs 20 kilos. (cement / builder)

3 They're using two. (cranes / men)

4 It needs about 4 litres. (oil / car)

5 I'm buying 150. (screws / you)

6 They can carry about 50 cubic metres. (concrete / ten trucks)

5 Read the text. Label the diagram with all the parts and dimensions in italics.

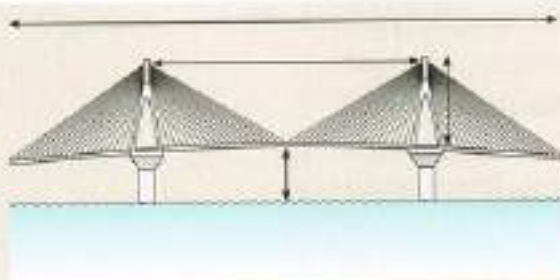

This cable-stay bridge has 20 *cables*. The *deck* of the bridge is 1.2 km long, and is 185 m above water level. Each *pier* is 35 m wide. The *span* between the two piers is 832 m long. Each *pylon* is 45 m high above the road deck.

6 Work in pairs. Order what you need to build the Burj Dubai skyscraper.

trucks / 40,000 cranes / 3 steel poles / 12,000
concrete / 150,000 m³ steel / 25,000 tonnes aluminium / 15,000 tonnes

A: I need to order some concrete/some trucks.

B: OK. How much concrete/How many trucks do you need?

A: I need ...

7 Complete the dialogue.

- Engineers are planning to build a tunnel **under** the sea.
- *Where will the tunnel be?*
- It'll be between Spain and Morocco.
- *How long (1) _____ be?*
- It (2) _____
- *How many (3) _____ have?*
- It (4) _____
- *How (5) _____?*
- It (6) _____
- *How (7) _____?*
- It (8) _____
- *When (9) _____ the engineers _____?*
- They (10) _____

Location:	• Between Spain and Morocco
Length:	• 40 km
Number of railway lines:	• 2
Width:	• 8 m
Depth (below sea level):	• 300 m
Completion date:	• 2025

8 Answer these questions.

1 Did they complete the Millau Bridge in 2000? (2004)

No, they didn't. They completed it in 2004.

2 Have you ever worked in an electronics company? (video shop)

3 Will they build a bridge from Africa to Europe? (a tunnel)

4 Are they constructing the tunnel now? (planning and designing)

5 Has NASA ever put men on Mars? (the Moon)

6 Did Russia launch the first satellite in 1960? (1957)

9 Rewrite the sentences using the present perfect tense.

Remember: don't use a time expression (such as *yesterday* or *an hour ago*) with the present perfect.

1 My car broke down five minutes ago.

My car has broken down.

2 NASA launched the space shuttle fifteen minutes ago.

3 A virus attacked our office computers two hours ago.

4 I wrote the email and I sent it to the customer yesterday.

5 The technician took the hard drive out of the computer an hour ago.

6 The exhaust pipe fell off my car ten minutes ago.

10 Look at the pictures. Say what's missing, in three different ways.

Example: 1 The wheel has no wheel nuts. / The wheel doesn't have any wheel nuts. / There are no wheel nuts on the wheel.



11 Complete the table.

Focus on action	Focus on result of action
1 He's dented the front bumper.	The front bumper is dented.
2 You've broken the windscreen.	
3 Someone has burnt the rear seat of the car.	
4 We've bent the poles of the scaffolding.	
5 They've torn the safety jackets.	
6 Someone has scratched the rear panel of the car.	

12 Complete the table.

1 He's bent the antenna.	The antenna is _____	There's a small _____ in the antenna.
2 The fire has burnt the walls.	The walls are _____	There are two large _____ on the walls.
3 You've cracked the window.	The window is _____	There are some _____ in the window.
4 I've torn my shirt.	My shirt is _____	There's a _____ in my shirt.

13 Rewrite these sentences to give the same or similar meaning.

- | | |
|--|----------------------------|
| 1 There's a scratch on this cover. | This cover is _____. |
| 2 There are no wheels on the car. | The car has _____. |
| 3 The cables don't have any plugs. | There are _____. |
| 4 The windscreens are cracked. | There are some _____. |
| 5 There's no workshop manual in this garage. | This garage doesn't _____. |
| 6 There is a dent in the roof of the car. | The roof _____. |

14 Complete this dialogue with the correct form of the verb in brackets.

- *Where did you buy your safety equipment?*
 - I (1) _____ (buy) it online, over the Internet.
- *That's good. How did you (2) _____ (find) the website?*
 - I (3) _____ (find) it through Google. I (4) _____ (key) in the words 'safety gear'.
- *How (5) _____ (you / pay) for it? Did you (6) _____ (use) your own bank card?*
 - No, no. My company (7) _____ (give) me a credit card last week. I (8) _____ (use) that.
- *That's great. When (9) _____ (you / receive) the goods?*
 - They (10) _____ (come) yesterday, by express mail.

15 Write a description of this water tower and how it works. Use the notes below.

Water tower
Function: store / water
Parts: The main parts of the water tower are ...
Materials: tower - galvanised steel
tank - aluminium and fibreglass
Dimensions: height & width
Volume: The tank can ...
How it works:
1 water / flow / to / pump
2 pump / push / water / to / city
3 extra water / flow / up / into / tank
4 tank / store / water
5 extra water / flow / down / from / tank / to / city

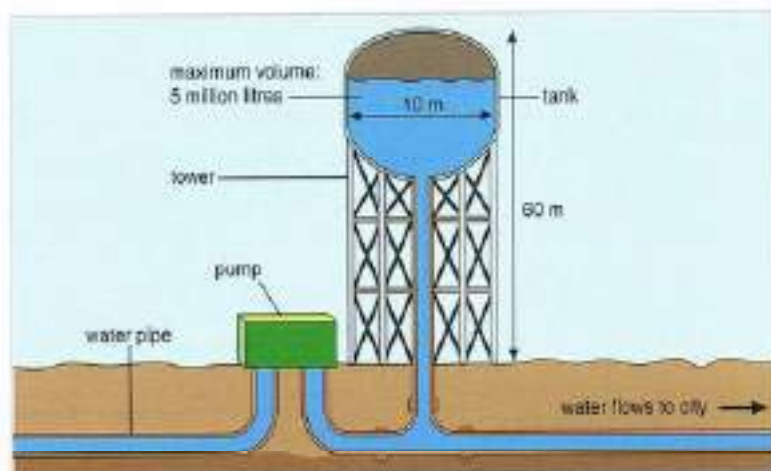

Projects 16 Choose one of these projects and follow the instructions.

- 1 Find out some facts about a famous structure (for example a bridge or building). Write a short article about it for an in-flight tourist magazine.
- 2 Design a new bridge, tunnel, or transport link (e.g. railway line or hovercraft route) to connect two places. Find out some facts about the location (for example, the width of a lake, the depth of the lake, the height of the land beside the lake, and so on). Write a short article about it for a technical magazine.
 - a) Draw a simple diagram of your design. Mark the dimensions.
 - b) Produce a specifications chart.
 - c) Write a short description.

1 Operation

Start here

- 1 Work in pairs. How does this vehicle move? Discuss with your partner.
- 2 What do the main parts do? Complete the chart.

Part	Function
	drive the fan
	pull the air in + force the air down
	control the speed and acceleration
	steer the airboard
	support the rider



Listening

- 3 47 Listen and check your answers.
- 4 Listen again and complete the dialogue.

● Look at the airboard. You can see the five main parts: the body, the engine, the fan, the handlebar and the two levers. The body (1) supports the rider and the engine (2) _____ the fan. The handlebar (3) _____ the airboard left and right.

- Ah yes, I see. So what (4) _____ the fan (5) _____?
- It (6) _____ the air in and (7) _____ it downwards.
- Right. And what (8) _____ the two levers (9) _____?
- They (10) _____ the speed and acceleration of the airboard.

downwards + upwards

Language

What	does	the engine	do?	It	drive	-s	the fan.
	do	the lever	-s	They	control		the speed.

- 5 Make short dialogues about the parts of the airboard.

- 1 fan / cool the engine? no → push air downwards
- 2 engine / drive the wheels? no → drive the fan
- 3 levers / stop the airboard? no → increase the speed
- 4 handlebars / control the brakes? no → steer the airboard

A: Does the fan cool the engine?

B: No, it doesn't.

A: So, what does it do?

B: It pushes air downwards.

THE AIRBOARD how it works

You stand on the airboard and ride it like a skateboard. The board moves on a cushion of air, like a small hovercraft. It has a fibreglass body, an engine, a large fan, a flexible rubber skirt, a friction wheel, a handlebar and two levers.

The engine and the fan are mounted on the body. The skirt and the friction wheel are suspended from the body. The handlebar is mounted on the body, at the front. The levers are attached to the handlebar.

The engine drives the fan. The function of the fan is to suck air in and to force

it downwards. This pushes the vehicle upwards and propels it forwards. On the body there is a fibreglass platform. This supports the rider. The skirt contains the air and the cushion of air supports the airboard. The rider uses the handlebar to steer the board. One lever controls the speed of the engine and the fan. The other lever controls the friction wheel. The friction wheel touches the ground for one or two seconds and accelerates the airboard into the air. If you want to stop, simply release the levers.



- 1 What is the friction wheel for?
- 2 Is the skirt above or below the body? What is it made of? Can you bend it?
- 3 Which part of the airboard does the rider stand on?
- 4 What happens if you take your hands off the levers?
- 5 Does *propel* (line 15) mean *pull*, *push*, *hold* or *control*?
- 6 Find words which mean the opposite of (1) *backwards* (2) *upwards*.

Language 7 Rewrite the sentences to give the same meaning.

- 1 The purpose of the handlebar is to steer the airboard.
- 2 The job of those levers is to control the speed of the airboard.
- 3 The function of the friction wheel is to accelerate the airboard.
- 4 The purpose of the fan and the engine is to propel the airboard forwards.
- 5 The function of the skirt is to hold the air and to support the airboard.
- 6 The job of the body and the platform is to support the rider.

Example: 1 The handlebar steers the airboard.

Vocabulary 8 Match the pictures with the sentences.

- | | |
|--------------------------|------------------------|
| 1 X is attached to Y. | 3 X is mounted on Y. |
| 2 X is suspended from Y. | 4 X is connected to Y. |



9 Complete these sentences. Use each phrase once only.

attached to connected to mounted on suspended from

- 1 The huge cables of the Millau Bridge are _____ steel pylons.
- 2 The pylons and the road deck are _____ concrete piers.
- 3 Close the circuit switch. Now the lamp is _____ the current.
- 4 The shelf is _____ the wall with screws.

2 Hotline

Listening 1  48 Listen to the automated message on the phone. The customer wants to talk to the service technician about a computer problem. Which three keys does the customer press?



2  49 The customer gets through to the service technician. What does the technician say? Complete the text below.



- Hello, you've (1) _____ the computer service hotline. This is Jan (2) _____. I'm the technician. How (3) _____ I (4) _____ you?

3  50 Listen to this phone call to a service hotline. What mistakes did the customer make when he set up his wireless router? Delete the wrong words.

- 1 The router *is/isn't* connected to the *power outlet/computer/modem*.
- 2 The customer *has/hasn't* connected the computer to the *power outlet/router/modem*.

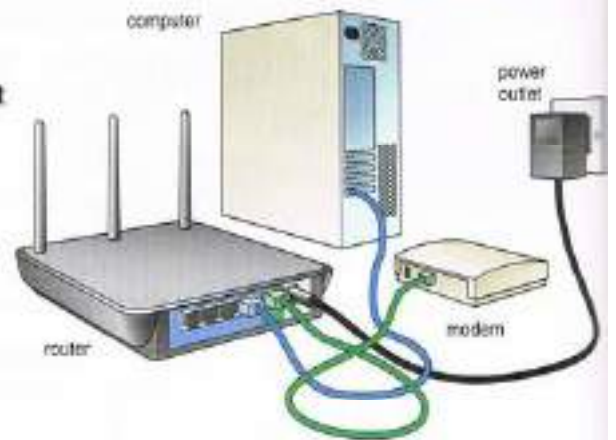

Speaking 4 Work in pairs. Practise similar conversations.

USEFUL LANGUAGE

Is the ... connected to the ...?
Have you connected your ... to the ...?

- Hello, is that the IT hotline?
- Yes, this is ... speaking. I'm the technician. How can I help you?
- My router *doesn't* work.
- OK. I'll talk you through it. Are you sitting at the computer now?
- Yes, I am.
- OK. Look at the back. Is the ... connected to the ...?

5 Work in pairs. Make more dialogues about the situations in these pictures.

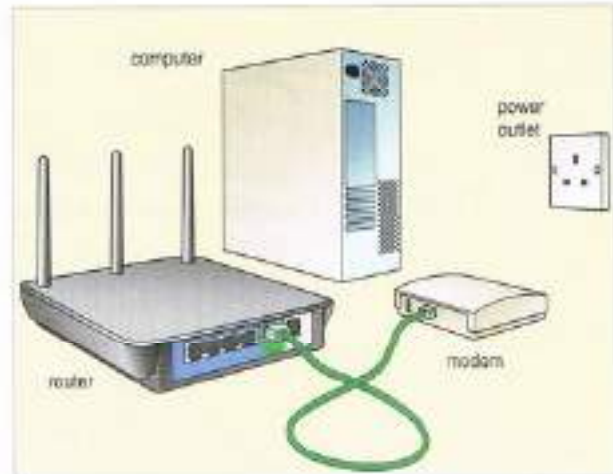
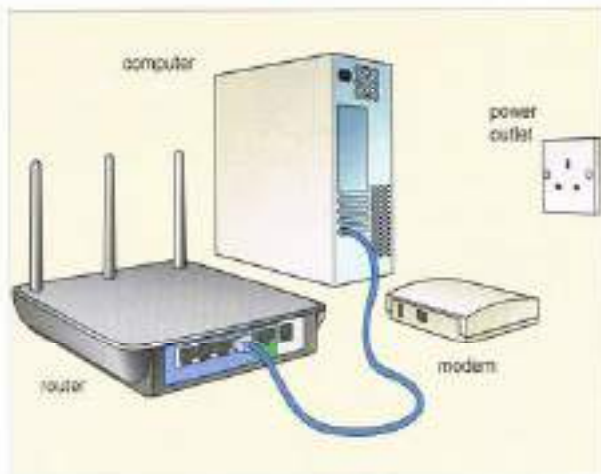

Language 6 Write short form answers for these questions.

- 1 Are the lights on? ✓ *Yes, they are.* ✗ *No, they aren't.*
- 2 Is the computer connected to the adapter?
✓ _____ ✗ _____
- 3 Have you sent the email?
✓ _____ ✗ _____
- 4 Does your new radio work?
✓ _____ ✗ _____
- 5 Did you go to the cinema yesterday?
✓ _____ ✗ _____
- 6 Can I speak to your brother?
✓ _____ ✗ _____
- 7 Do you work in the city?
✓ _____ ✗ _____
- 8 Are you sitting at the computer now?
✓ _____ ✗ _____
- 9 Do those speakers cost a lot of money?
✓ _____ ✗ _____
- 10 Has your car broken down?
✓ _____ ✗ _____

7 **51** Look at 6 again and listen to the questions and answers. You will hear only one answer to each question. Repeat each answer.

Task 8 Work in pairs. Find out all the differences between your wiring diagram and your partner's.

Hint: there are at least ten differences of (a) location of sockets and (b) wiring connection.

Instructions.

- Student A, turn to page 117.
- Student B, this is your wiring diagram.

USEFUL LANGUAGE

digital receiver, DVD, VCR, TV, antenna, SCART socket, RF socket, in, out, power, socket

- Do you have a/an ... ?
- Look at the ...
- Where is the ... ?
- Does the ... connect to the ... ?
- Have you connected the ... to the ... ?
- Is the ... connected to the ... ?

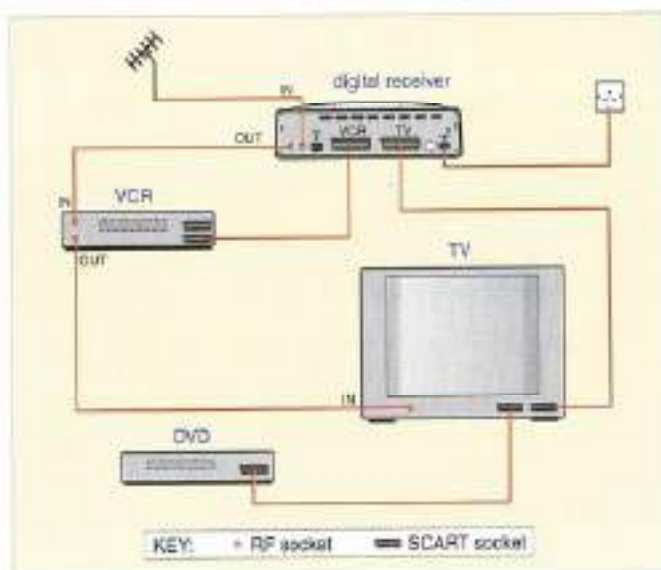

3 User guide

Start here 1  52 Listen and complete the flow chart.

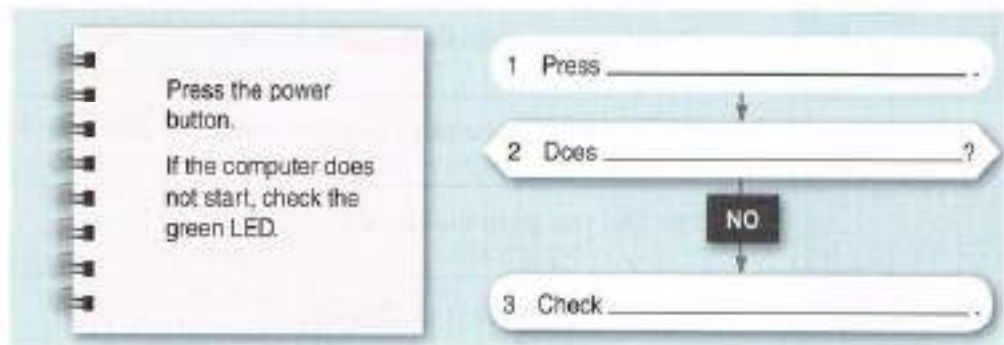

Reading 2 Draw a similar flow chart based on the solutions in this troubleshooting guide.

Notebook computer – troubleshooting FAQ

I pressed the power button and opened the display, but the computer does not start or boot-up.

Try these solutions:

- 1 Press the power button again.
- 2 If the computer does not start, check the green LED.
- 3 If the green LED is off, check the power source.
- 4 If the power source is off, switch on the power and press the power button again.
- 5 If the computer does not start, check the disk drive.
- 6 If there is a disk in the drive, take it out and press the power button again.

Language

Condition	Instruction
If the car starts,	drive away.
the car doesn't start,	check the battery.
the light is off,	press the power button.
there is a disk in the drive,	take it out.

3 Make sentences with *if* from these short dialogues.

1 ● Is the light on? ● No, it isn't. ● OK. Press the switch.	3 ● Are there any numbers on the screen? ● No, there aren't. ● OK. Press the keys.	5 ● Is the battery flat? ● Yes, it is. ● OK. Either replace it or recharge it.
2 ● Does the airboard start? ● No, it doesn't. ● OK. Turn the key.	4 ● Are the LEDs off? ● Yes, they are. ● OK. Push the power button.	6 ● Do the speakers work? ● Yes, they do. ● OK. Connect them to the computer.

Example: 1 *If the light isn't on, press the switch.*

4 Draw a flow chart. Use the information from the text.

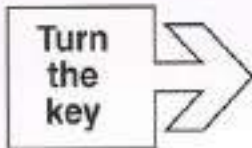

Turn the key. If the car starts, drive away. But if the car doesn't start, check the battery. If the battery doesn't work, recharge it. If the battery works, check the starter motor.

Writing 5 Write a troubleshooting guide based on this dialogue. Write six sentences.

- Hello, service hotline here, Mike speaking. How can I help you?
- Hello, I've got a problem with my printer. It doesn't print.
- OK. First check the cable between the printer and your computer. Is it loose?
- Yes, it is.
- OK. Connect the cable. Now check the power. Is the printer on?
- Yes, it is.
- Right. Now try to print. Is it printing?
- No, it isn't.
- OK. Now check the paper. Is there any paper in the printer?
- No, there isn't.
- OK. Put some paper in the printer. Now try to print again. Does it print?
- No, it doesn't.
- All right. Switch off and wait for ten seconds. Then switch on again.
- It's printing! Thanks for your help.
- You're welcome. Goodbye.

Begin:

- 1 If you can't print, check the cable between the printer and the computer.
- 2 If the cable is loose, connect ... and check ...

Social English 6 Complete the dialogues with short answers.

- 1 ● Do you live near here?
○ _____ I live less than a kilometre away.
- 2 ● Do you work at BMW?
○ _____ I work at Mercedes.
- 3 ● Are you in IT?
○ _____ I'm in engineering.
- 4 ● Have we met before?
○ _____ We met at the conference.
- 5 ● Did you drive here?
○ _____ I came by train.

7 Work in pairs. Practise the dialogue in 6.

8 Work in pairs. Make similar dialogues, using the information below.

more than 20 miles away / Citroën - Renault / R&D + quality control / in Paris / cycle + bus

دبلوم تقنية السلامة والصحة المهنية

الحقيبة التدريبية

اللغة الإنجليزية 1

وصف اللغة الإنجليزية 1 :

مقرر اللغة الإنجليزية (1) هو مقرر تأسيسي يهدف إلى تنمية المهارات الأساسية في اللغة الإنجليزية لدى المتدربين، حيث يركز على بناء قاعدة قوية في الاستماع، والتحدث، والقراءة، والكتابة. يتناول المقرر المفردات الأساسية والتراكيب اللغوية البسيطة، إضافة إلى قواعد اللغة الأولية التي تساعد المتدرب على تكوين جمل

كما يسعى المقرر إلى تمكين المتدرب من فهم النصوص القصيرة، والتعبير عن نفسه بشكل مبسط، واستخدام اللغة في بيئات الحياة والعمل، مما يشكل أساساً قوياً لـ انتقال إلى مستويات متقدمة

تواصل معنا عبر حساباتنا الرسمية

0534835311
0558133778
@ACDMBO @A_BWABHALROWAD طريق الملك عبدالله



055 813 3778 - 053 483 5311



www.alruwad.edu.sa

نتمنى لكم دوام التوفيق والنجاح